

VLP-170

PRODUCT GUIDE

Absolute
Rotary Encoder

Hollow Shaft
Kit Encoder



Table of Contents

1.	VLP Encoders Introduction	4
2.	Technical Specifications	5
3.	Ordering Code	6
4.	Mechanical Drawings	7
5.	Mechanical Interface Control Drawing	8
6.	Storage and Handling	9
7.	ESD Protection	9
8.	Product Overview	9-10
8.1	Overview	9
8.2	Unpacking - Standard order	10
8.3	Installation flow chart	10
9.	Electric Encoder Software Installation	11
9.1	Minimum requirements	11
9.2	Installing the software	11
10.	Mechanical Mounting	11-12
10.1	Encoder mounting - End-of-Shaft Installation	11
11.	Electrical Connection	13-16
11.1	Absolute position over SSi or BiSS-C	13
11.2	Digital SSi Interface	14
11.3	Digital BiSS-C Interface	15
11.4	Setup mode over NCP (Netzer Communication Protocol)	16
11.5	Electrical connection and grounding	16
12.	Signal Verification	17-19
12.1	Starting the Encoder Explorer	17
12.2	Signal verification process	18
13.	Calibration	21-30
13.1	Auto-calibration	21
13.2	Manual calibration	24
13.3	Setting the encoder zero-position	28
13.4	Jitter test	29
14.	Operational Mode	30
9.1	SSi / BiSS	30

1. VLP Encoders Introduction

Designed to meet the requirements of the most demanding applications

The VLP series of Electric Encoders™ are a line of encoders designed for harsh environment applications.

These encoders are based on capacitive technology which have been developed and improved for over 20 years by Netzer Precision Position Sensors.

The VLP encoders are characterized by the following features that sets them apart from other similar encoders:

- Low profile (<8 mm)
- Hollow shaft (Stator / Rotor)
- No bearings or other contact elements
- High resolution and excellent precision
- Immunity to magnetic fields
- High tolerance to temperature extremes, shock, moisture, EMI, RFI
- Very low weight
- Holistic signal generation and sensing
- Digital interfaces for absolute position

The holistic structure of the VLP Electric Encoder™ makes it unique. Its output reading is the averaged outcome of the entire circumference area of the rotor. This inherent design characteristic provides the VLP encoder with outstanding precision as well as a tolerant mechanical mounting.

The absence of components such as ball bearings, flexible couplers, glass discs, light sources & detectors, along with very low power consumption, enables the VLP encoders to deliver virtually failure-free performance.

2. Technical Specifications

General

Angular resolution	19-21 bit
Nominal position accuracy	$\pm 0.006^\circ$
Maximum operational speed	2,000 rpm
Measurement range	Single turn, unlimited
Rotation direction	Adjustable CW/CCW*
Built In Test BIT	Optional

* Default same direction from bottom side of the encoder

Mechanical

Allowable mounting eccentricity	± 0.1 mm
Allowable axial mounting tolerance	± 0.3 mm
Rotor inertia	205,330 gr · mm ²
Total weight	110 gr
Outer Ø / Inner Ø / Height	170 / 110 / 8 mm
Material (stator / rotor)	FR4
Nominal air gap (stator, rotor)	1 mm

Electrical

Supply voltage	5V \pm 5%
Current consumption	~90 mA
Interconnection	Cable (standard 250 mm)
Communication	SSi, BiSS-C
Output code	Binary
Serial output	Differential RS-422
Clock frequency	0.1-5.0 MHz
Position update rate	35 kHz (Optional - up to 375 kHz)

Environmental

EMC	MIL-STD-461G RE102 / RS 103
Operating temperature	-40°C to +105°C
Storage temperature	-55°C to +125°C
Relative humidity	98% Non condensing
Shock endurance / functional	100g 6msec saw-tooth per IEC 60068-2-27:2009 40g 11msec saw-tooth per MIL-810G
Vibration functional	7.7grms @ 20 to 2000 Hz per MIL-810G Category 24
Protection	IP 40

3. Ordering Code

VLP - 170 - S H - S O - n n n n

VLP Product Line

Outer Diameter

Output	
S	SSi
I	BiSS

Resolution		
Code	Bit	CPR
H	19	524,288
I	20	1,048,578
J	21*	2,097,156

*SSi only

BIT (Built In Test): Optional	
[]	None
B	BIT

Custom

Cable Length	
0	250 mm Flying leads - 30AWG
1	500 mm Flying leads - 30AWG
2	750 mm Flying leads - 30AWG
3	1000 mm Flying leads - 30AWG
4	250 mm Flying leads - 28AWG
5	500 mm Flying leads - 28AWG
6	750 mm Flying leads - 28AWG
7	1000 mm Flying leads - 28AWG

To add a connector contact us

Cable Options	
S	Jacket and shielded cable
B	Shielded cable
W	Wires only

4. Mechanical Drawings

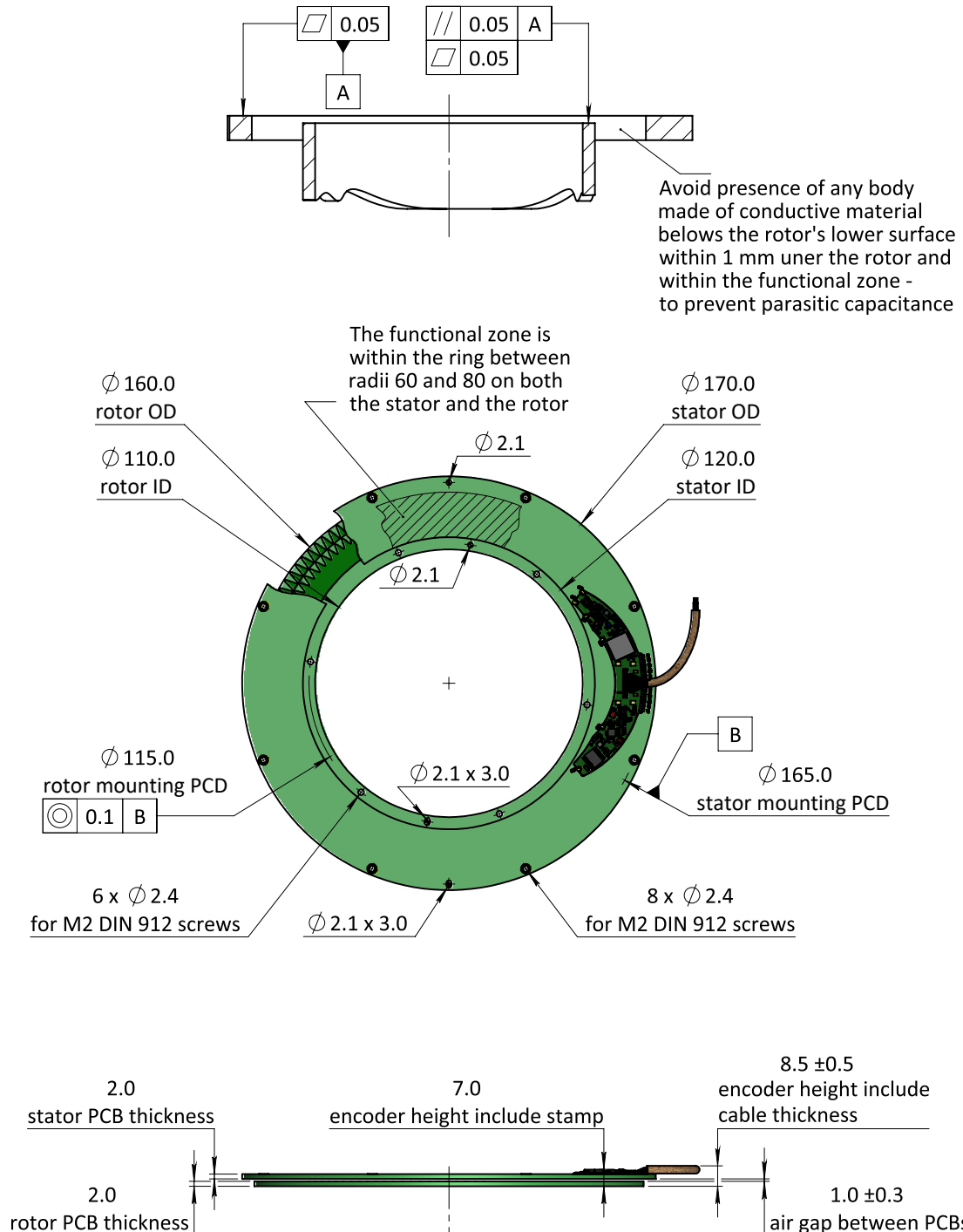

Unless otherwise specified

Dimensions are in: mm	Surface finish: N6
Linear tolerances	
0.5-4.9: ± 0.05 mm	5-30: ± 0.1 mm
31-120: ± 0.15 mm	121-400: ± 0.2 mm

5. Mechanical Interface Control Drawing

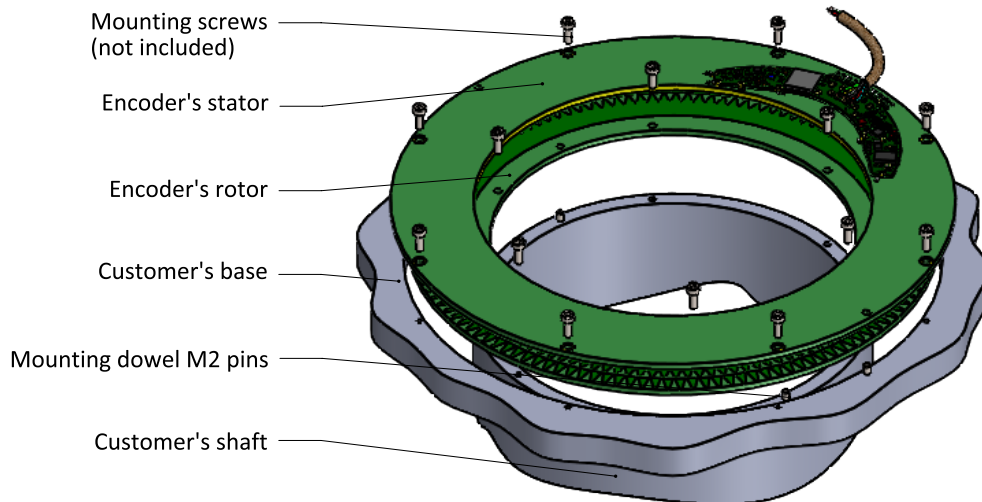

Cable options

Netzer Cat No.	CB 00014	CB 00034
Cable type	30 AWG twisted pair x 3	28 AWG twisted pair x 3
Wire type	2 x 30 AWG 25/44 tinned copper Insulation: PFE Ø 0.15 OD: Ø 0.6 ± 0.05 mm	2 x 30 AWG 40/44 tinned copper Insulation: PFE Ø 0.12 OD: Ø 0.64 ± 0.05 mm
Temp. Rating	-55°C to +150°C	
Braided shield	Thinned copper braided 95% min. coverage	
Jacket	0.45 silicon rubber (NFA 11-A1)	0.44 silicon rubber (NFA 11-A1)
Diameter	Ø 2.45 ± 0.16 mm	Ø 3.53 ± 0.16 mm

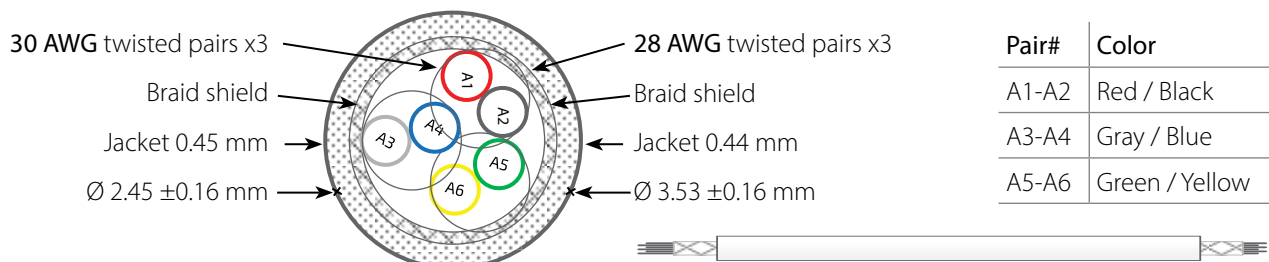

6. Storage and Handling

Storage temperature: -55°C to +125 °C

Humidity: Up to 98% non-condensing

7. ESD Protection

As usual for electronic circuits, during product handling do not touch electronic circuits, wires, connectors or sensors without suitable ESD protection. The integrator / operator shall use ESD equipment to avoid the risk of circuit damage.



ATTENTION

OBSERVE PRECAUTIONS FOR HANDLING
ELECTROSTATIC SENSITIVE DEVICES

8. Product Overview

8.1 Overview

The VLP-170 absolute position Electric Encoder™ is a rotary position sensor developed for demanding applications. Currently it performs in a broad range of applications, including defense, homeland security, medical robotics and industrial automation.

The Electric Encoder™ non-contact technology provides accurate position measurement through the modulation of an electric field.

The VLP-170 Electric Encoder™ is a kit-encoder, i.e., its rotor and stator are separate.

- (1) Encoder stator
- (2) Encoder rotor

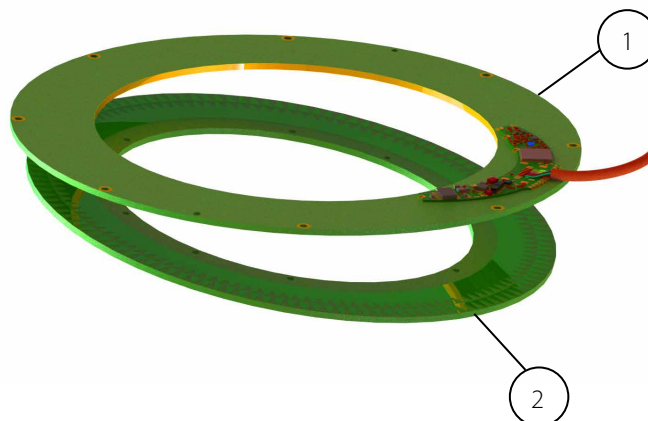

8.2 Unpacking - standard order

The package of the standard VLP-170 contains the encoder Stator & Rotor.

Optional accessories:

- (1) CNV-0003, RS-422 to USB converter (with USB internal 5V power supply path).
- (2) NanoMIC-KIT-01, RS-422 to USB converter. Setup & Operational modes via SSi /BiSS interface.
- (3) RJ VLP-170 rotary jig
- (4) DKIT-VLP-170-SG-S0, Mounted SSi encoder on rotary jig, RS-422 to USB converter and cables.
- (5) DKIT-VLP-170-IG-S0, Mounted BiSS encoder on rotary jig, RS-422 to USB converter and cables.

8.3 Installation flow chart

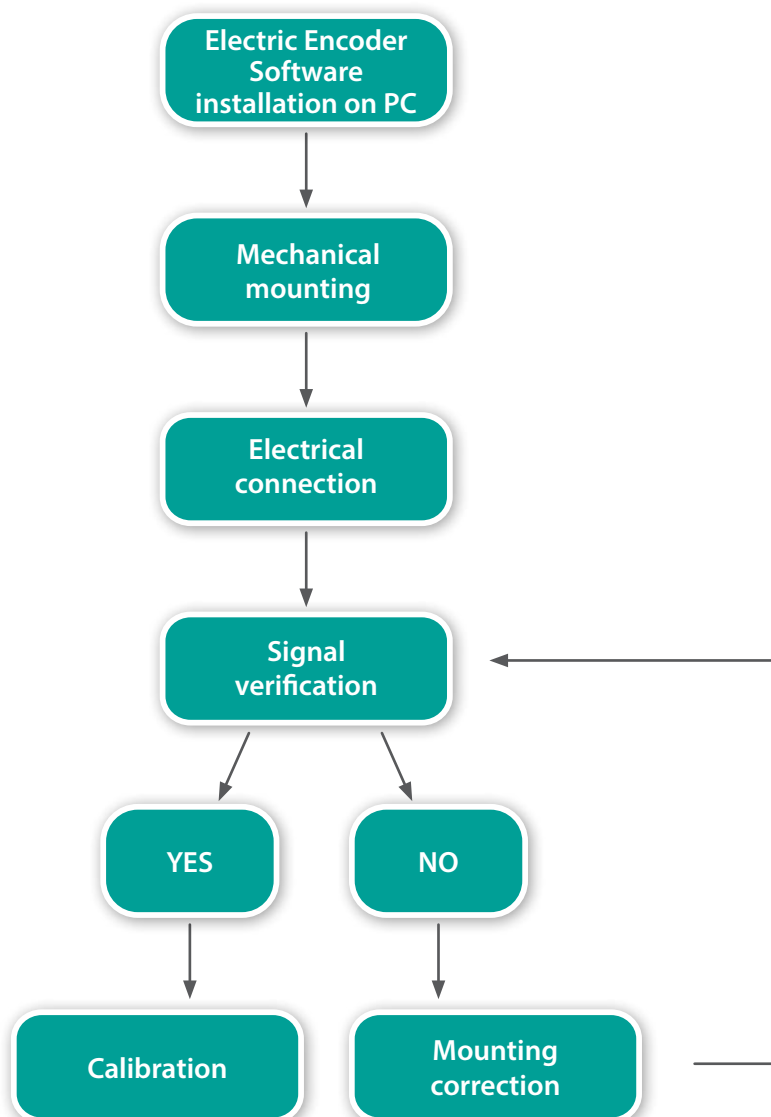

9. Electric Encoder Software Installation



The Electric Encoder Explorer (EEE) software:

- Verifies correct mounting for an adequate signal amplitude
- Calibration of offsets
- General set up and signal analysis

This section describes the steps associated with installing the EEE software application.

9.1 Minimum requirements

- Operating system: MS windows 7/ 10, (32 / 64 bit)
- Memory: 4MB minimum
- Communication ports: USB 2
- Windows .NET Framework, V4 minimum

9.2 Installing the software

- Run the Electric Encoder™ Explorer file found on Netzer website: [Encoder Explorer Software Tools](#)
- After the installation you will see **Electric Encoder Explorer software icon** on the computer desktop.
- Click on the Electric Encoder Explorer software **icon** to start.

10. Mechanical Mounting

10.1 Encoder mounting - End-of-Shaft Installation

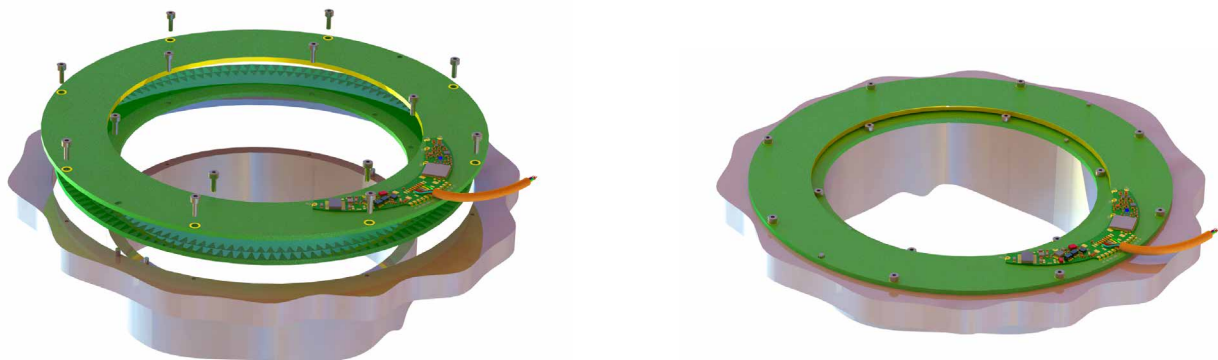

Typical encoder installation uses

- Mounting screws Socket Head Cup Screw 12xM2, 6 each per stator & rotor.
- Mounting dowel pins 4xØ2, 2 each per stator & rotor (not included with the encoder).

Encoder stator / Rotor relative position

For proper performance the air gap should be $1.0\text{ mm} \pm 0.1\text{ mm}$

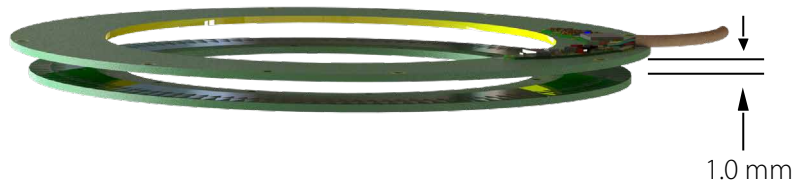

In an optimal mounting, the signal amplitude values generated by the encoder, would be in the middle of the range of the signal plot shown in the Encoder Explorer software (see plot below). This may vary according to the encoder type.

Verify proper rotor mounting with the Encoder Explorer tools “Signal analyzer” or “Signal verification process.”

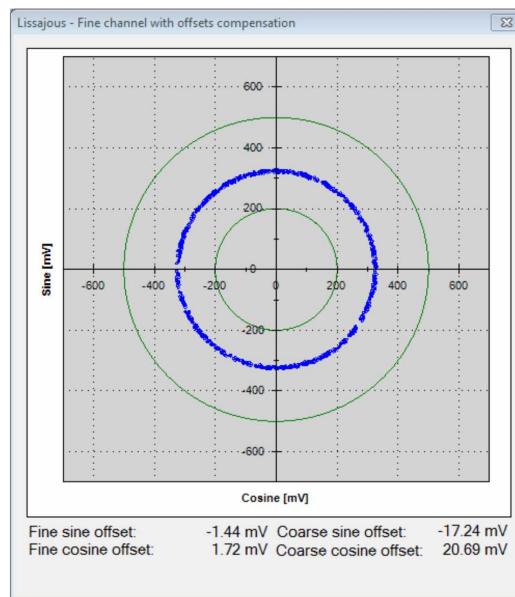

Note: for more information please read section 7

11. Electrical Connection

This chapter reviews the steps required to electrically connect the encoder with digital interface (SSi or BiSS-C).

Connecting the encoder

The encoder has two operational modes:

11.1 Absolute position over SSi or BiSS-C

This is the power-up default mode

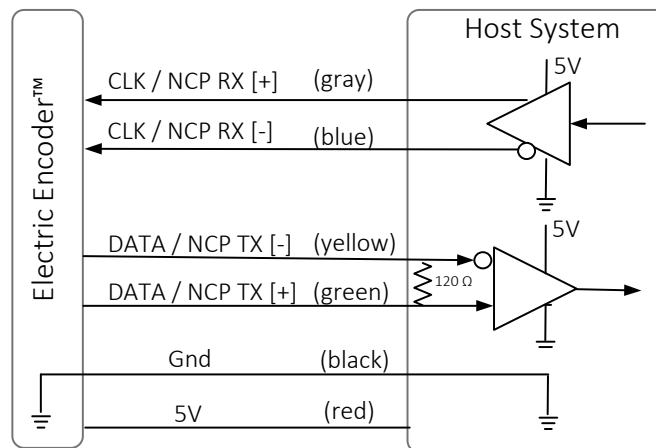

SSi / BiSS interface wires color code

Clock +	Grey	Clock
Clock -	Blue	
Data -	Yellow	Data
Data +	Green	
GND	Black	Ground
+5V	Red	Power supply

SSi / BiSS output signal parameters

Output code	Binary
Serial output	Differential RS-422
Clock	Differential RS-422
Clock frequency	0.1 ÷ 5.0 MHz
Position update rate	35 kHz (Optional - up to 375 kHz)

11.2 Digital SSI Interface



Synchronous Serial Interface (SSI) is a point to point serial interface standard between a master (e.g. controller) and a slave (e.g. sensor) for digital data transmission.

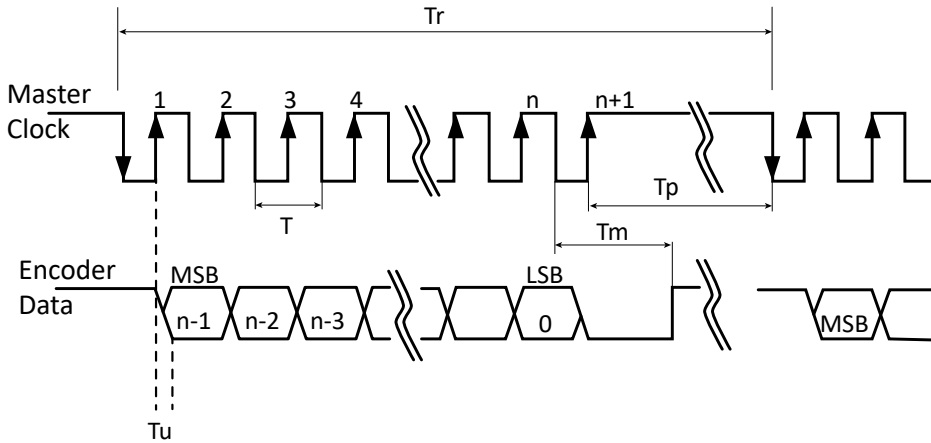

Built In Test option (BIT)

The BIT indicates critical abnormality in the encoder internal signals.

'0' – the internal signals are within the normal limits, '1' – Error

The Part Number of the encoder indicates whether the encoder includes BIT. If no BIT is indicated in the PN, there is no additional error bit.

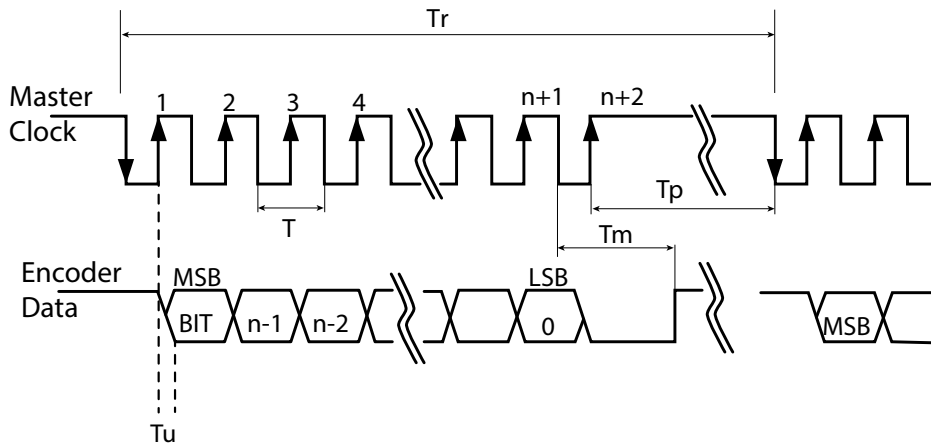

	Description	Recommendations
n	Position resolution	12-21
T	Clock period	
$f = 1/T$	Clock frequency	0.1-5.0 MHz
Tu	Bit update time	90 nsec
Tp	Pause time	26 - ∞ μsec
Tm	Monoflop time	25 μsec
Tr	Time between 2 adjacent requests	$Tr > n * T + 26 \mu\text{sec}$
$fr = 1/Tr$	Data request frequency	

11.3 Digital BiSS-C Interface



BiSS – C Interface is unidirectional serial synchronous protocol for digital data transmission where the Encoder acts as “slave” transmits data according to “Master” clock. The BiSS protocol is designed in B mode and C mode (continuous mode). The BiSS-C interface as the SSi is based on RS-422 standards.

Built In Test option (BIT)

The BIT indicates critical abnormality in the encoder internal signals.

'1' – the internal signals are within the normal limits, '0' – Error

The Part Number of the encoder indicates whether the encoder includes BIT. If no BIT is indicated in the PN, the error bit is always 1.

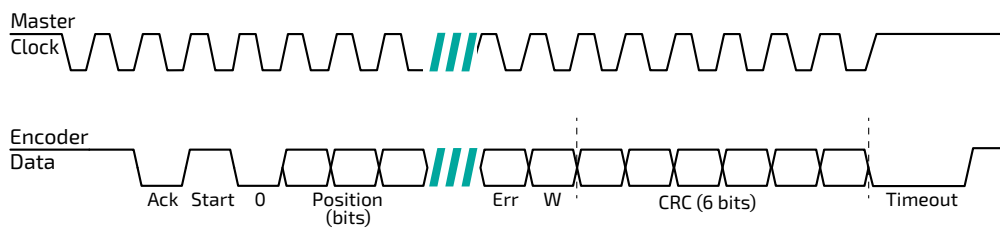

Bit allocation per encoder-resolution				Description		Default	Length
17bit	18bit	19bit	20bit				
27	28	29	30	Ack	Period during which the encoder calculates the absolute position, one clock cycle	0	1/clock
26	27	28	29	Start	Encoder signal for “start” data transmit	1	1 bit
25	26	27	28	“0”	“Start” bit follower	0	1 bit
8...24	8...25	8...26	8...27	AP	Absolute Position encoder data		Per resolution
7	7	7	7	Error	BIT (Built In Test option)	1	1 bit
6	6	6	6	Warn.	Warning (non active)	1	1 bit
0...5	0...5	0...5	0...5	CRC	The CRC polynomial for position, error and warning data is: $x^6 + x^1 + x^0$. It is transmitted MSB first and inverted. The start bit and “0” bit are omitted from the CRC calculation.		6 bits
				Timeout	Elapse between the sequential “start”request cycle’s		25 μs

11.4 Setup mode over NCP (Netzer Communication Protocol)

This service mode provides access via USB to a PC running Netzer Encoder Explorer application (on MS Windows 7/10). Communication is via Netzer Communication Protocol (NCP) over RS-422 using the same set of wires.

Use the following pin assignment to connect the encoder to a 9-pin D-type connector to the RS-422/USB converter CNV-0003 or the NanoMIC.

Electric encoder interface, D Type 9 pin Female

Description	Color	Function	Pin No
SSi Clock / NCP RX	Gray	Clock / RX +	2
	Blue	Clock / RX -	1
SSi Data / NCP TX	Yellow	Data / TX -	4
	Green	Data / TX +	3
Ground	Black	GND	5
Power supply	Red	+5V	8

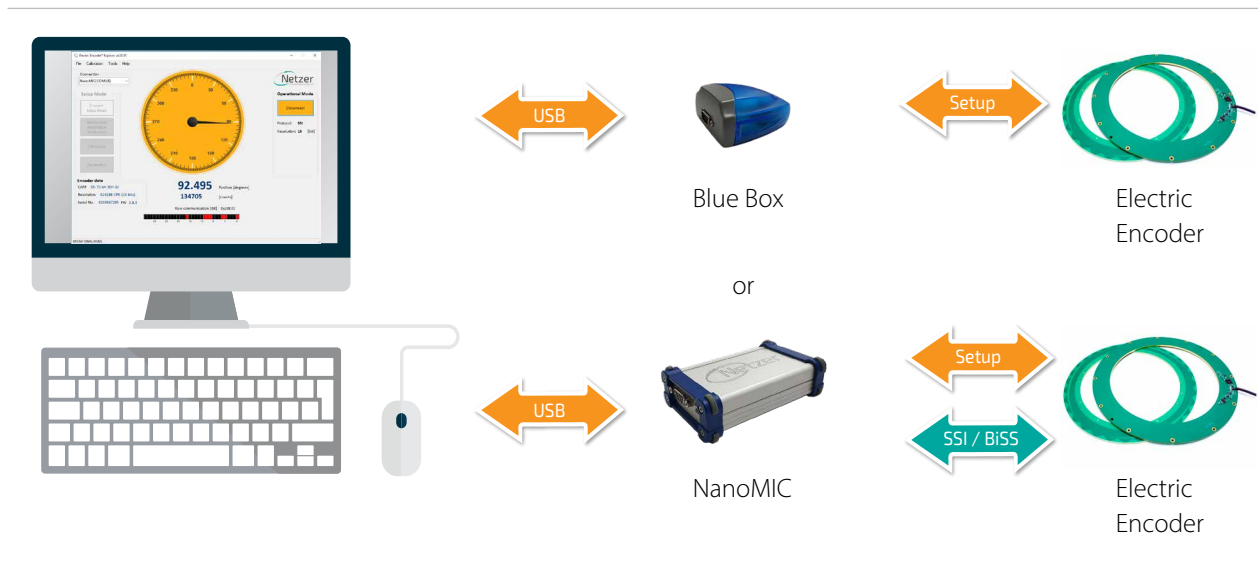

Connect Netzer encoder to the converter, connect the converter to the computer and run the Electric Encoder Explorer Software Tool

11.5 Electrical connection and grounding

Observe the following grounding consideration:

1. The cable shield electrically floating (unconnected) by default.
2. It's highly recommended to keep the motor PWM wires electrically shielded and/or kept away from the encoder.

Note: 4.75 to 5.25 VDC power supply required

12. Signal Verification

12.1 Starting the Encoder Explorer

Make sure to complete the following tasks successfully:

- Mechanical Mounting
- Electrical Connection to the encoder
- Encoder Explore Software Installation

Run the Encoder Explorer tool (EE)

Ensure proper communication with the encoder: (Setup mode by default).

The Encoder position-dial is colored blue when in Setup Mode, either through the NanoMic or the BlueBox (a).

Note that the operational mode is not available through the BlueBox (b).

The Signal amplitude bar indicates whether the signal is within the acceptable tolerance (c). Note that prior to performing the Signal Verification process the bar could indicate an out of tolerance signal (d).

Encoder data is displayed in the encoder data area (CAT No., Serial No.) (e).

The position dial display responds to shaft rotation (f).

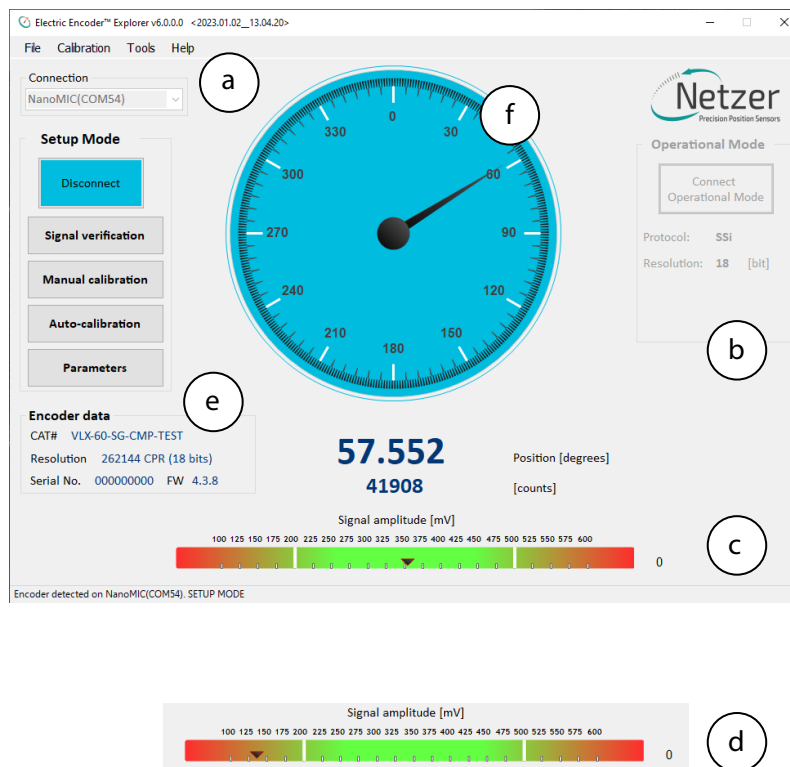

It is important to perform the Signal Verification process prior to the calibration of the encoder to ensure optimal performance.

12.2 Signal verification process

The Signal Verification process ensures that the encoder is mounted correctly and provides good signal amplitudes. This is performed by collecting raw data of the fine and coarse channels during rotation.

- Select <Signal Verification> on the main screen (a).

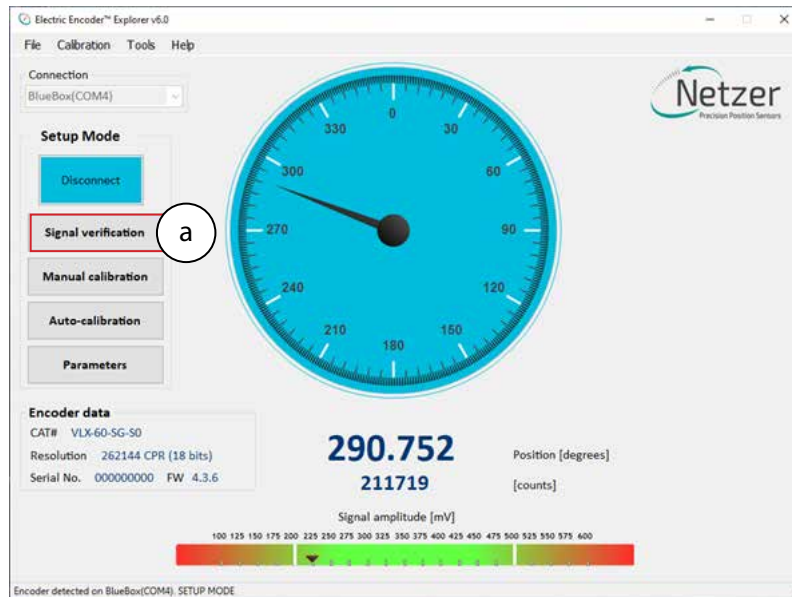

- Select the appropriate measurement range applicable to your application (b).
- Select <Start> to initiate the process (c).

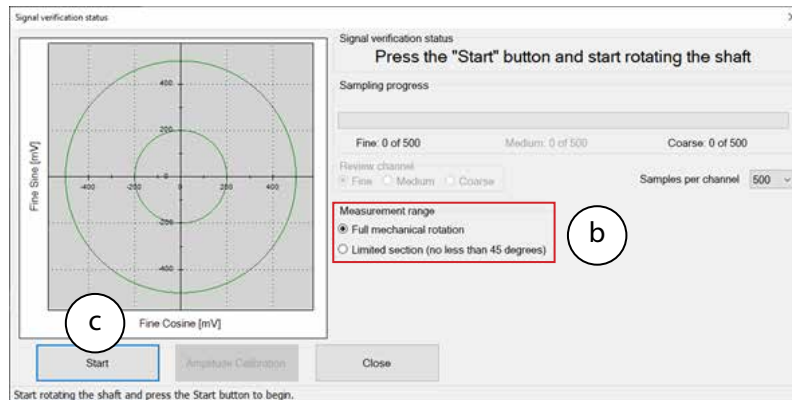

- Rotate the shaft in order to collect the fine and coarse channels data (d).

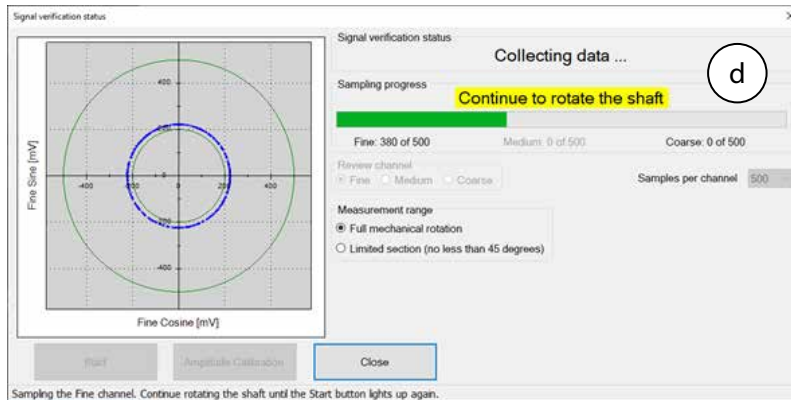

If the process is successful, the status “Signal verification successful” would appear (e).

The ‘amplitude circle’ would be centered between the two green circles, preferably in the middle of the tolerance (f).

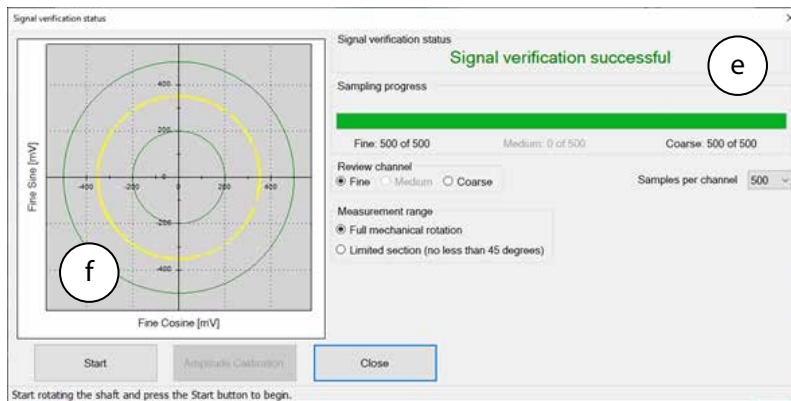

Note however, that mounting the encoder towards the extreme mechanical tolerances might cause the amplitude circle to be offset from the exact middle of the nominal position.

If the signal is out of tolerance the Error notification “Amplitude is lower/higher than the min/max limit of XXX” would appear (g).

In Addition, the status “Signal verification failed – perform calibration amplitude” would appear at the top (h).

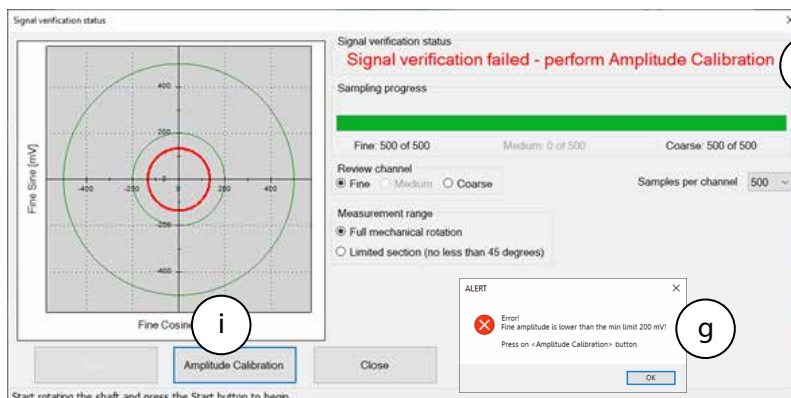

Click Ok and Click on the <Amplitude Calibration> button (i).

This process would calibrate the signal amplitudes to ensure an optimal signal, accounting for installation tolerances.

Follow the series of on-screen prompts:

- Start rotating the shaft and press <OK>
- When the “stop rotation” notification appears, stop the shaft and press <OK>

If Amplitude Calibration is successful, the status “Signal amplitudes calibrated successfully” would appear (j). Close the notification, and repeat the Signal Verification process by clicking the <Start> button (k).

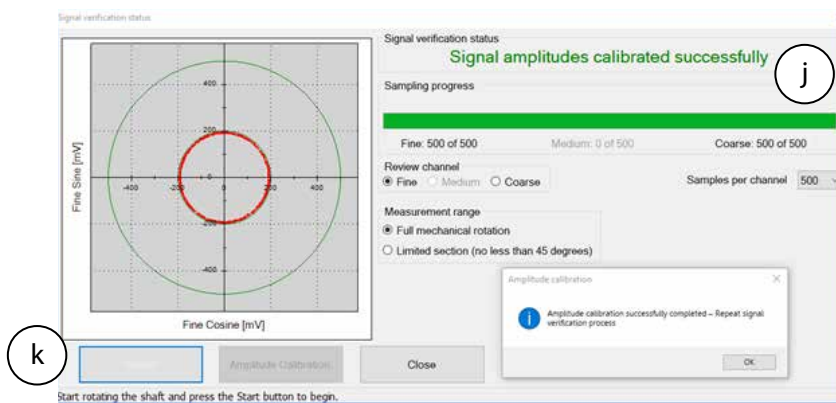

If the calibration is not possible, the Error notification “Amplitudes out of tolerance. Faulty mounting” appear (l) and the status “Amplitude calibration failed - Remount encoder” would appear at the top (p).

- Stop the process and re-mount the encoder, making sure that the mechanical installation tolerances are not exceeded.

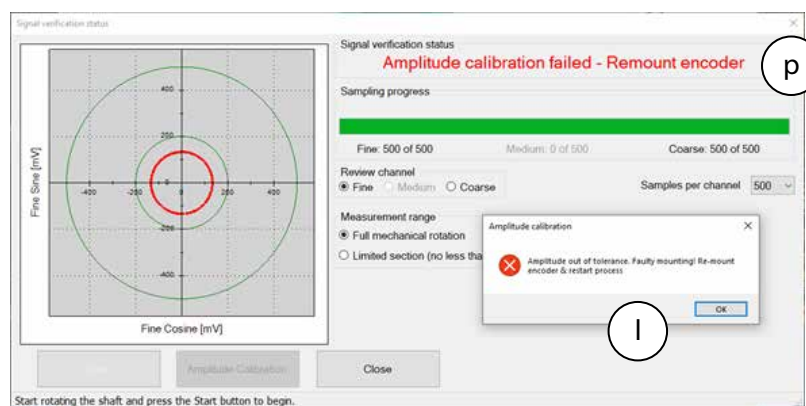

- Repeat the Signal Verification process after the remount.

Once the signal verification process is successfully completed, proceed to the encoder calibration phase, Section 13

13. Calibration

It is important that upon every installation of the encoder, the Signal Verification process is completed prior to attempting calibration of the encoder.

For encoders with FW 4 version 4.1.3 or higher, it is possible to select either a fully automated calibration process, or a manual phase-by-phase calibration process.

13.1 Auto-calibration

Auto Calibration is supported by encoders with FW 4 version 4.1.3 or higher.

For these encoders an additional "Auto-calibration" button is displayed.

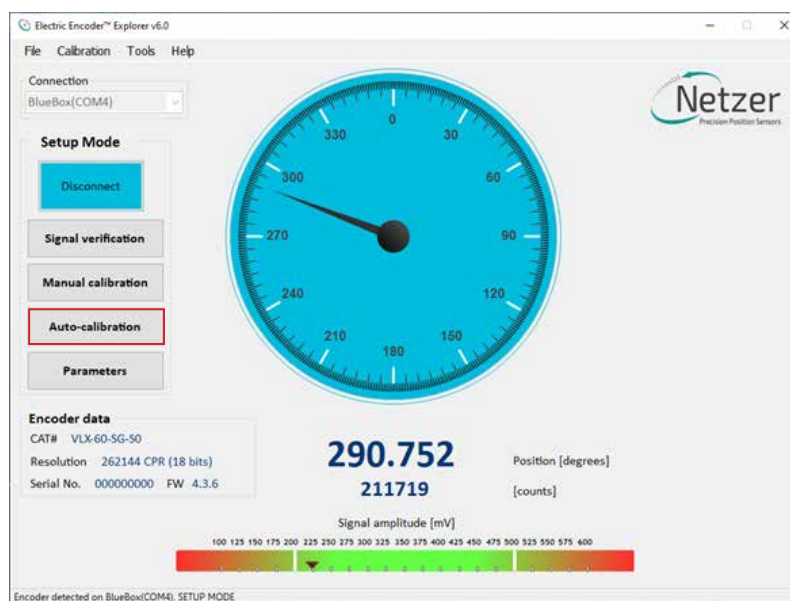

13.1.1 Auto-calibration process

The Auto-calibration process consists of three stages:

- Jitter test** - evaluates the electric noise for the Fine, Medium, and Coarse encoder channels. During the jitter test, the shaft must be stationary.
Attention! The Pass/Fail criteria of the Jitter test is according to very strict factory criteria and failing it would abort the Auto Calibration process.
However, the manual Jitter test as part of the Manual Calibration process in section 13.4, would enable the user to decide whether the jitter is acceptable to its needs.
- Offset calibration** - performs the offset calibration, the shaft must rotate continuously.
- Absolute Position (AP) calibration** - performs Coarse Amplitude Alignment (CAA) and Medium Amplitude Alignment (MAA) are calculated.

During Auto-Calibration process the encoder's Zero-Position remain in the factory default zero position for new encoders. It is possible to set the Zero Point through the top menu bar, by selecting "Calibration" tab, and clicking "Set UZP" as defined in section 13.3.

13.1.2 Performing Auto-calibration

Press the <Auto-calibration> button.

The main auto-calibration window opens.

- Select the appropriate measurement range applicable to your application (a).

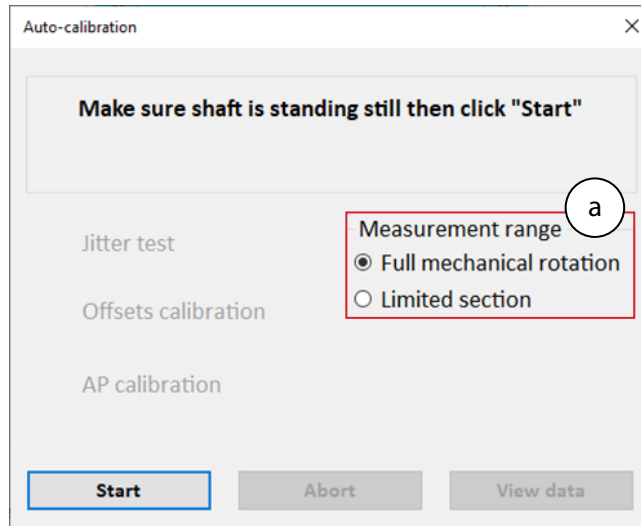

- Make sure to keep the shaft still and press the <Start>

The Noise test would be performed and upon successful completion the "Noise test" label will be marked with a green check mark.

The Offset calibration would automatically start upon completion of the Noise test. This calibration requires that the shaft be rotated continuously.

The AP calibration would automatically start upon completion of the Accuracy Calibration. Continue rotating the shaft in this phase until the AP calibration is completed, and the encoder is reset.

Once the reset is over, the Auto-calibration process is successfully finished.

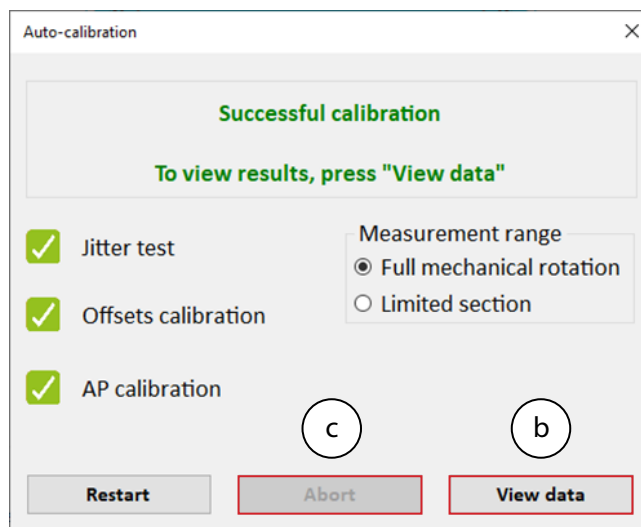

The user can review the calibration results by clicking the <View data> button (b).

Auto-calibration result		
Offsets [mV]		
	Before	After
Fine sine offset	-2.01	-1.87
Fine cosine offset	-0.57	-0.36
Medium sine offset		N/A
Medium cosine offset		N/A
Coarse sine offset	-8.69	-8.62
Coarse cosine offset	16.23	16.23
CAA [electrical degrees]		
	Before calibration	After calibration
CAA	3.52	3.52
MAA		N/A

It is always possible to abort the Auto Calibration process by clicking the <Abort> button (c).

13.1.3 Auto-calibration failures

If a test fails (for example the Noise test) – the result will be marked with in red X.

Calibration failed

✘ Jitter test

Offsets calibration

AP calibration

Measurement range

Full mechanical rotation

Limited section

Restart
Abort
View data

If the calibration process failed, corrective recommendations will be displayed, corresponding to the element which had failed the test.

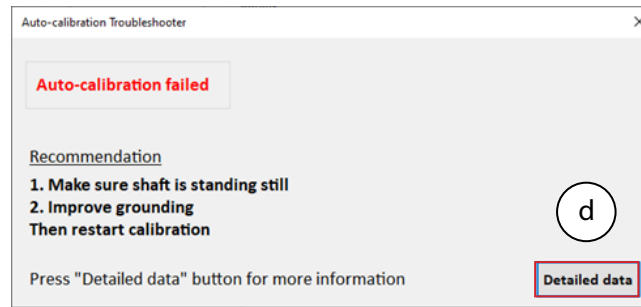

It is possible to review detailed information regarding the failure, by clicking the <Detailed data> button (d).

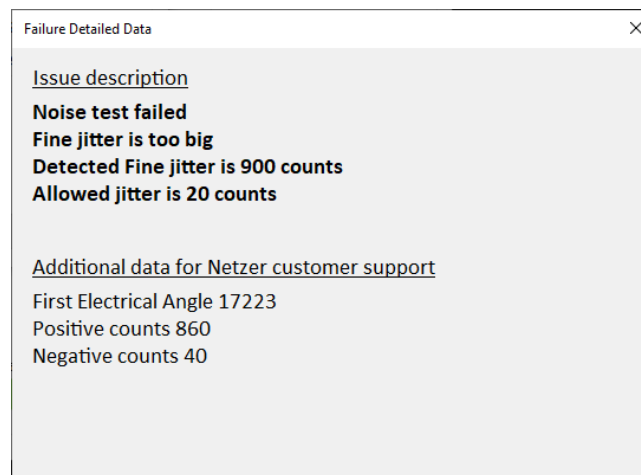

13.2 Manual calibration

The Manual calibration process consists of the following stages:

1. **Offset calibration** - performs the offset calibration, the shaft must rotate continuously.
2. **CAA / MAA Calibration** - performs Coarse Amplitude Alignment (CAA) and Medium Amplitude Alignment (MAA) are calculated
3. **Zero Position Set** - Used to determine a Zero Position other than the factory default.
4. **Jitter Test** - Used to determine the amount of jitter and allow the user to decide if acceptable.

- Select <Manual Calibration> on the main screen (a).

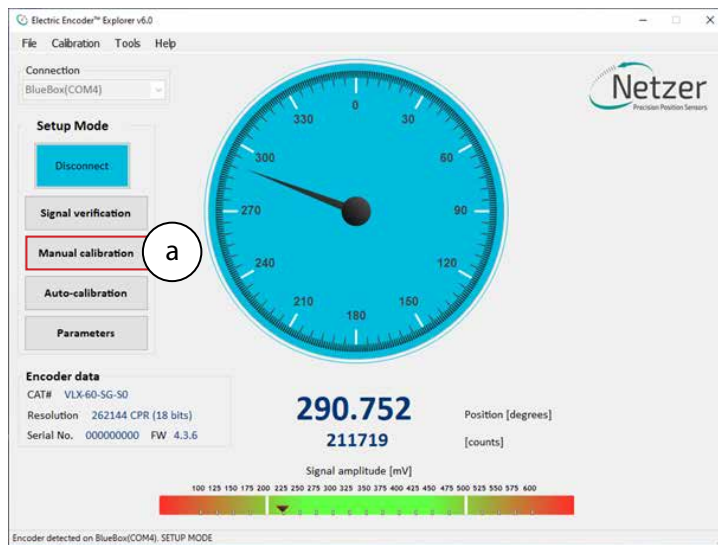

13.2.1 Offset calibration

In this process, the DC offset of the sine and cosine signals are compensated over the operational sector (offset calibration).

- Click <Start data acquisition> (b).
- Rotate the shaft continuously during data collection, covering the whole working sector of the application from end to end. The progress bar (c) indicates the progress of the data collection.

Rotation speed is not a parameter during data collection. By default, the procedure collects 500 points. The collected data for the fine / coarse channels, should be a clear "thin" circle which appears in the center of the plots (d) (e) with a possible slight offset.

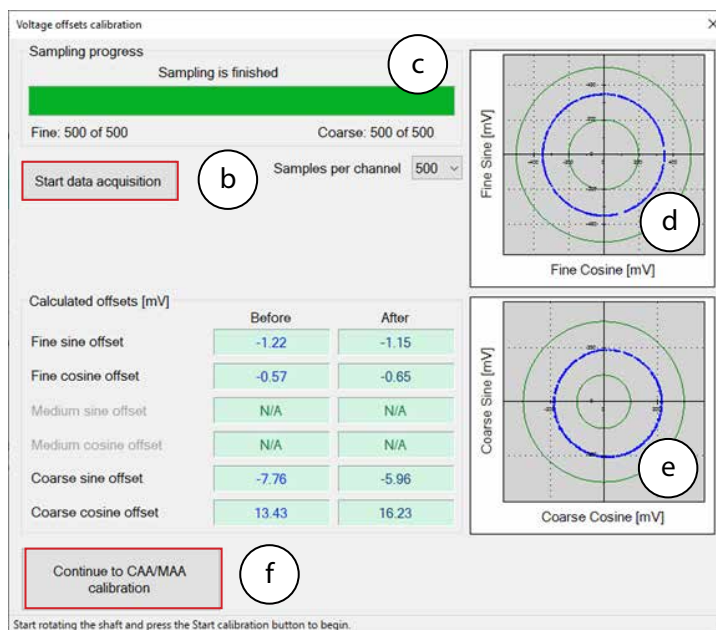

- When offset calibration is completed, click on <Continue to CAA/MAA Calibration> button (f).

13.2.2 Calibration of Coarse Amplitude Alignment (CAA) & Medium Amplitude Alignment (MAA)

The following calibration aligns the coarse channel, and medium channel in certain encoders, with the fine channel by collecting data from each point in both channels. This is performed to make sure that every time the encoder is turned on, it would provide an accurate absolute position.

- Select the relevant option from the Measurement Range options (a):

Full mechanical rotation - shaft movement is over a full 360 degrees rotation – (that is the recommended calibration).

Limited section - shaft has a limited rotation angle which is less than 360 degrees. In this mode you need to input the rotation range by degrees.

Free sampling mode - sets the number of calibration points in accordance with the total number of points in the text box. The system displays the recommended number of points by default. The minimum points over the working sector is nine.

Note that the Total number of points would change to the optimal default according to the selected measurement range above.

- Click the <Start Calibration> button (b).

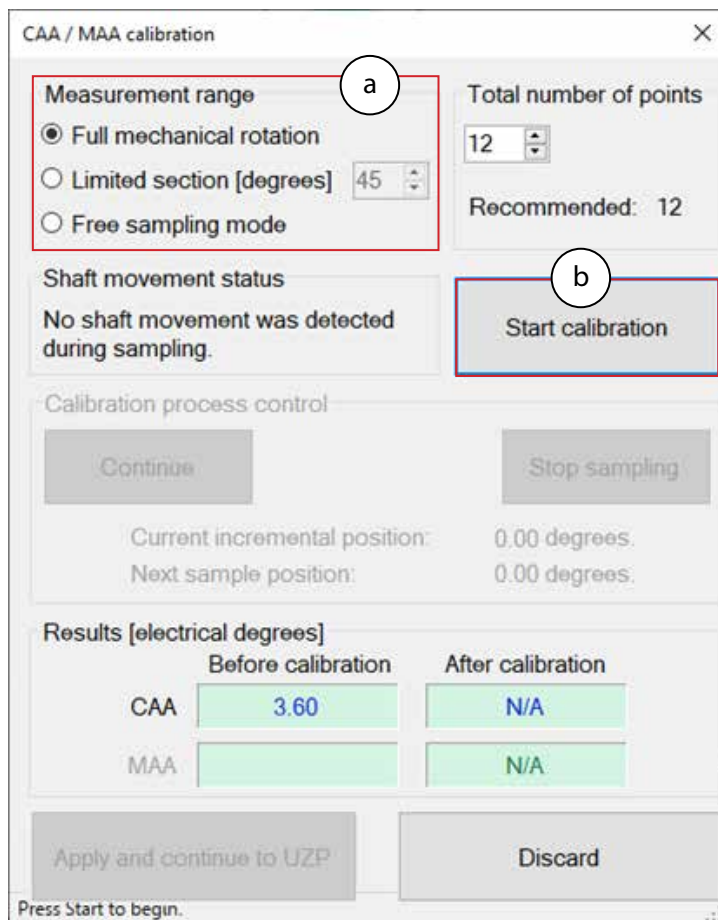

CAA / MAA calibration		
Measurement range (a)		
<input checked="" type="radio"/> Full mechanical rotation <input type="radio"/> Limited section [degrees] 45 <input type="radio"/> Free sampling mode		
Total number of points 12 Recommended: 12		
Shaft movement status No shaft movement was detected during sampling.		
Start calibration (b)		
Calibration process control Continue Stop sampling		
Current incremental position: 0.00 degrees. Next sample position: 0.00 degrees.		
Results [electrical degrees]		
	Before calibration	After calibration
CAA	3.60	N/A
MAA		N/A
Apply and continue to UZP		Discard
Press Start to begin.		

The Calibration process control (c) indicates the current position, and the next target position to which the shaft should be rotated.

- Rotate the shaft to the next position, stop and click the <Continue> button to sample the position (d).

The shaft should be at STAND STILL when clicking the button.

Measurement range		Total number of points
<input checked="" type="radio"/> Full mechanical rotation		12
<input type="radio"/> Limited section [degrees]	45	Recommended: 12
<input type="radio"/> Free sampling mode		

Shaft movement status
No shaft movement was detected during sampling. (e)

Calibration process control
Continue (d) Sampled 2/12 Stop sampling

(c) Current incremental position: 297.58 degrees.
Next sample position: 300.00 degrees.

	Before calibration	After calibration
CAA	3.60	N/A
MAA		N/A

(f) Apply and continue to UZP Discard

Rotate the shaft to 300.00 degrees, and press Continue.

The Shaft movement status (e) indicates the shaft movement status.

- Complete the sampling process using the following routine: positioning the shaft --> stand still --> clicking <Continue> (d) to sample the position.
- When the process is completed click the <Apply and Continue to UZP> button (f).

13.3 Setting the zero-position of the encoder

- Select one of the options for setting the zero point and click <Apply and close>.

It is possible to set either current position or rotate the shaft to any other position to be set as the zero point.

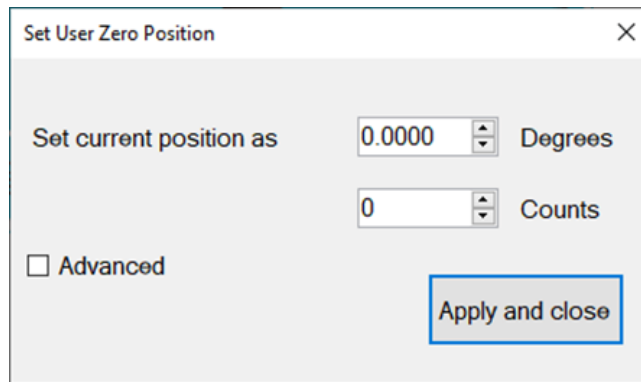

It is also possible to set the Zero Point through the top menu bar, by selecting “Calibration” tab, and clicking “Set UZP”.

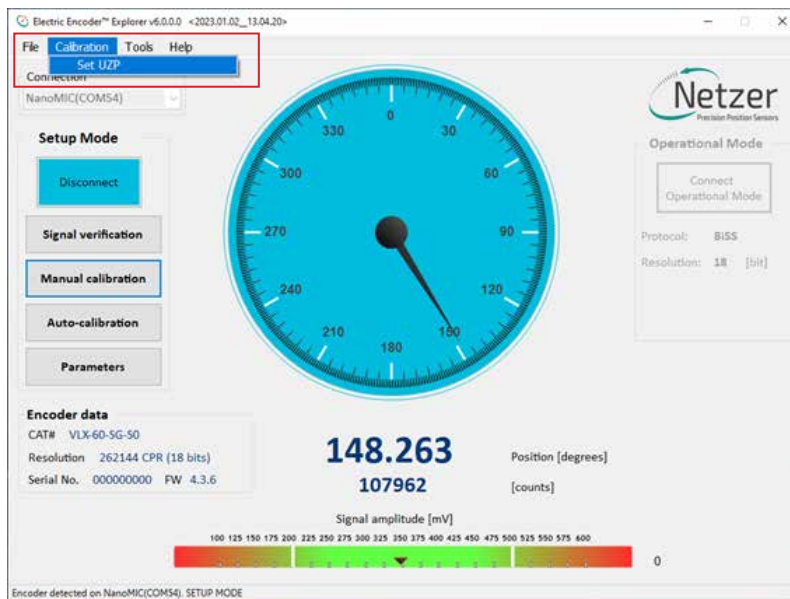

13.4 Jitter test

The jitter test is used evaluate the level of electric noise.

Common jitter should be up +/- 3 counts; higher jitter may indicate system noise and would require better grounding or shielding of the electric noise source.

- Select "Calibration" tab, and click "Jitter Test"

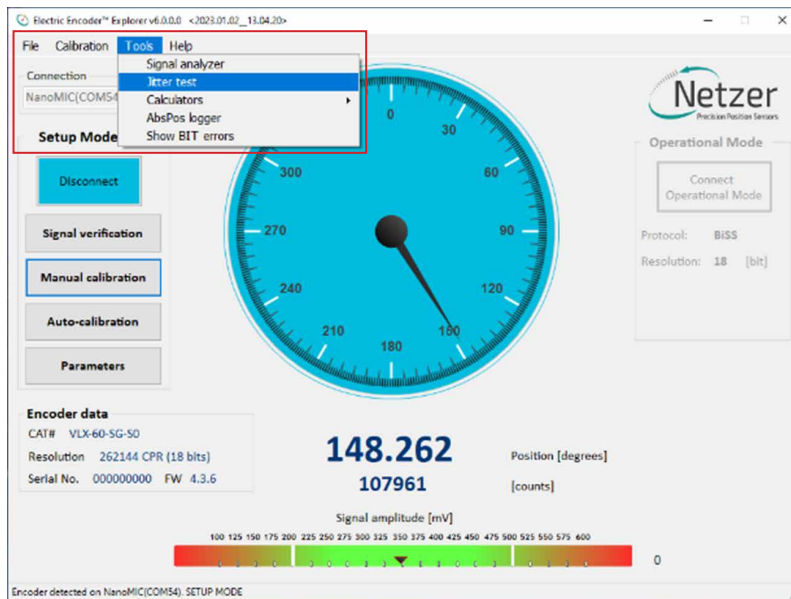

- Select the Jitter test mode (a).
- Set the Timing and Sampling parameters (b).
- Click <Start> button (c) and check if the results (d) are within acceptable tolerances for the intended application.



Another indication of excessive jitter/noise when the blue dots in signal amplitude circle are not evenly distributed on a thin circle as appears below.

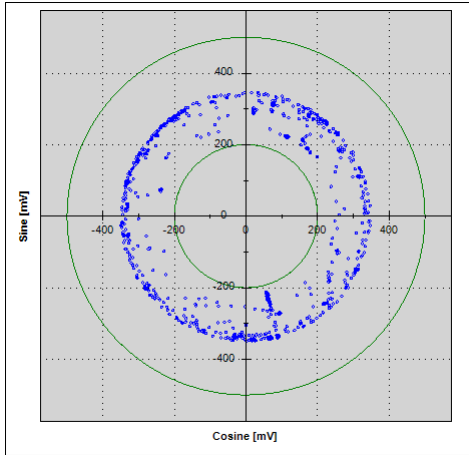

Excessive jitter/noise

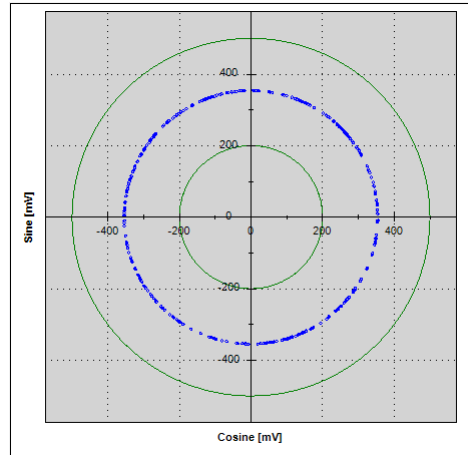

Low jitter/noise

14. Operational Mode

14.1 SSI / BiSS

Operational Mode indication of the SSI / BiSS encoder interface is available by using the NanoMIC to connect with the encoder. When in Operational Mode the color of the position dial is orange.

[For more information read about NanoMIC on Netzer website](#)

The operational mode is using SSI / BiSS interface with 1MHz clock rate.

The encoder position-dial is colored orange when in Operational Mode. The bar below the dial, is the corresponding binary word output for the current shaft position (a).

SSI Protocol

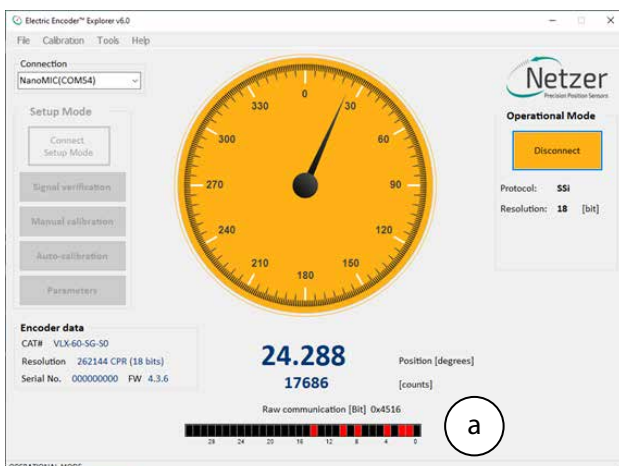

BiSS Protocol

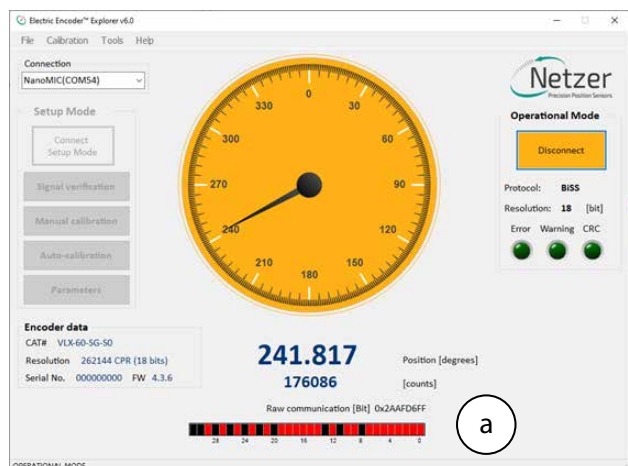



Corporate Headquarters

Netzer Precision Position Sensors A.C.S. Ltd.
Misgav Industrial Park, P.O. Box 1359
D.N. Misgav, 2017400 Israel
Tel: +972 4 999 0420

www.netzerprecision.com