

ELECTRICAL OPTIONS/ SPECIFICATIONS

OUTPUT	SUPPLY		
0.5 TO 4.5V RATIOMETRIC	5V		
SUPPLY CURRENT 12mA TYP. 20mA MAX.			
CABLE: 0.2mm ² , O/A SCREEN, PUR JACKET – SUPPLIED WITH 50cm OR REQUIRED LENGTH IN cm (15000cm MAX).			
STANDARD 3-CORE: JACKET Ø4mm BLACK e.g. L50			
OPTIONAL 5-CORE: JACKET Ø4.6mm BLUE e.g. LQ50			
CABLE/CONNECTOR* CONNECTIONS;			
3 CORE	5 CORE	CONNECTOR	
RED	RED	:1	+Ve
-	ORG	:1	+SENSE (5-WIRE ONLY)
BLACK	BLACK	:3	0V
-	GRY	:3	-SENSE (5-WIRE ONLY)
WHITE	WHITE	:2	OUTPUT
SCREEN	SCREEN	:4	BODY

*CONNECTORS; MAXIMUM CONDUCTOR CROSS SECTION 0.75mm²
 RANGE OF DISPLACEMENT FROM 0–2mm TO 0–50mm e.g.36, IN INCREMENTS OF 1mm.

BODY MATERIAL: STAINLESS STEEL.
 FLANGE MATERIAL: STAINLESS STEEL (CODE 'N')

FURTHER OPTIONS:
 SINGLE PAIR OF BODY CLAMPS (CODE 'P')
 SPRUNG PLUNGER, TO EXTENDED POSITION (CODE 'R')
 DOME END (CODE 'T') IN CONJUNCTION WITH SPRUNG PLUNGER (CODE 'R')**

PLUNGER FREE (CODE 'V')
 N.b. NOT AVAILABLE WITH SPRUNG OPTIONS.



NOTE:– READ INSTALLATION SHEET M103–19 FOR FULL INSTRUCTIONS FOR USE.

ATEX / IECEx APPROVED TO
 I/II M1/1GD
 Ex ia IIC T4 Ga (Ta= -40° to +80°C)
 Ex ia IIIC T135°C Da (Ta= -40° to +80°C)
 Ex ia I Ma (Ta= -40° to +80°C)
 Ui 11.4V, li 0.2A, Pi 0.51W

APPROVED FOR USE IN CONJUNCTION WITH A GALVANICALLY ISOLATED BARRIER.
 NOTE: APPROVAL ONLY APPLIES AT NORMAL ATMOSPHERIC PRESSURE!

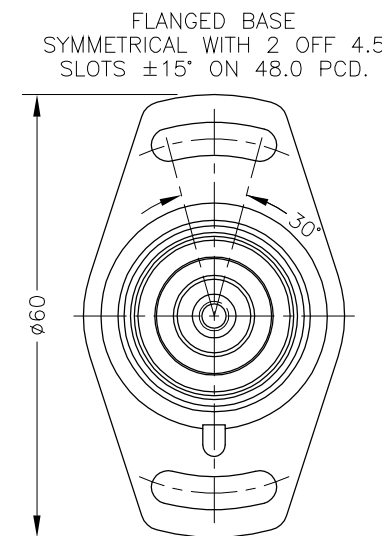
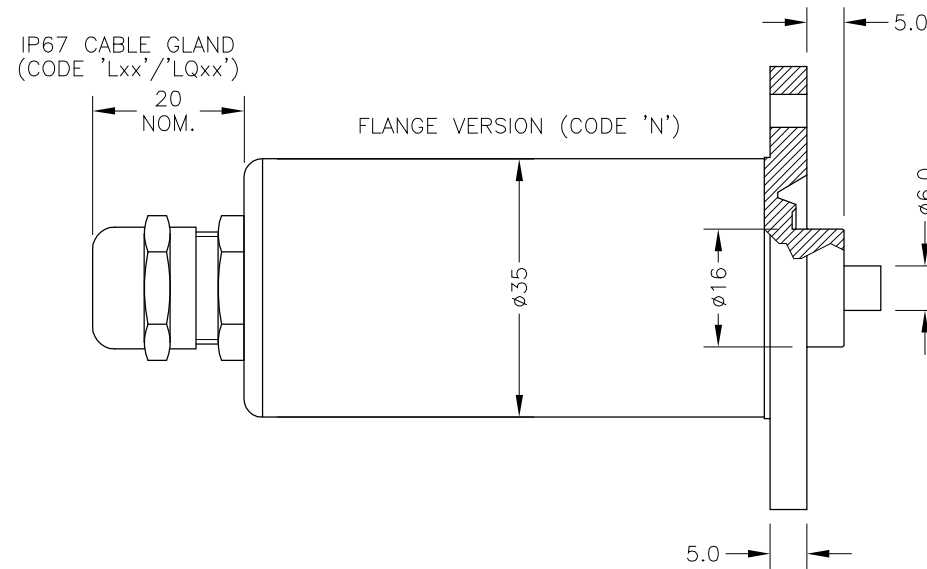
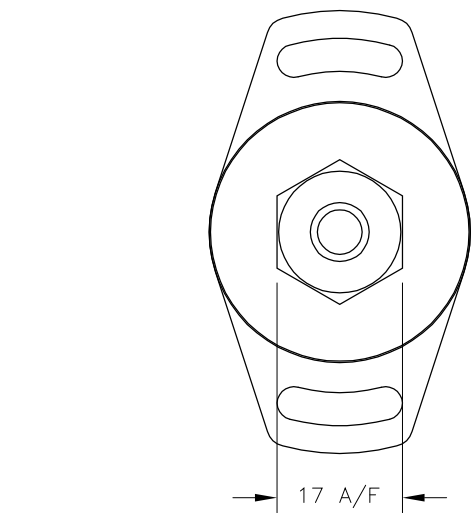

IP67 SHORT CABLE GLAND (CODE 'Mxx'/'MQxx')

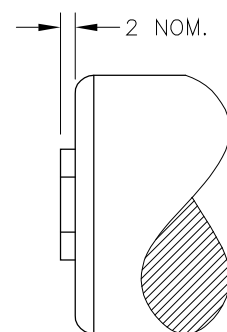

NOTE: SENSORS WITH TRAVEL UP TO 50mm ARE MADE IN STANDARD LENGTHS.

TRAVEL: (mm)	BODY LENGTH: (mm)
CALIBRATED MECHANICAL	'Y' FLANGE
0–2 TO 0–10	10
0–11 TO 0–20	20
0–21 TO 0–30	30
0–31 TO 0–50	50
	81.3
	91.3
	101.3
	121.3

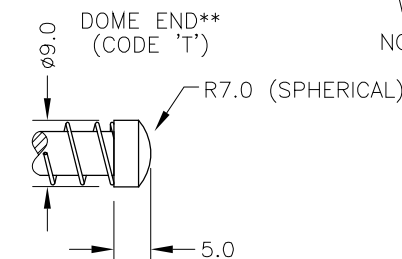

H	STROKE NOTES AMENDED.	PDM
I	APPROVAL STANDARDS UPDATED - RAN465.	PDM
J	STROKE 2-10 WAS 10 - RAN1063	PDM
K	5-CORE OPTION ADDED ~ RAN1102	PDM
L	OPTION 'M' ADDED ~ RAN1166, RANGE NOTE AMENDED ~ RAN1200	PDM



THE PLUNGER RETRACTS 5mm FROM START OF CALIBRATED TRAVEL (2mm FOR SPRUNG VERSIONS) AND EXTENDS 9.5mm* BEYOND END OF MECHANICAL TRAVEL. *DOES NOT INCLUDE DIFFERENCE BETWEEN CALIBRATED AND MECHANICAL TRAVEL, DIMENSIONS ARE NOMINAL. 'V' CODED PLUNGER WILL DEPART SENSOR BODY.

DRAWINGS NOT TO BE CHANGED WITHOUT REFERENCE TO THE CHANGE PROCEDURE.
 CHANGES TO PARTS USED IN INTRINSICALLY SAFE PRODUCT MUST BE APPROVED BY THE AUTHORISED PERSON
 THIS IS AN UNCONTROLLED PRINT AND WILL NOT BE UPDATED.



H	21/11/13		CHECKED BY	X	±0.4
I	10/03/14		RDS	X.X	±0.2
J	10/11/15			X.XX	±0.1
					DIMS mm
K	10/04/17	DESCRIPTION			
L	29/08/17	M103 INTRINSICALLY SAFE SHORT STROKE LINEAR POSITION SENSOR			
SCALE 10mm		DRAWING NUMBER		M103-11	REV L
					SHEET 1 OF 1

LIPS[®] M103 SHORT STROKE LINEAR POSITION SENSOR INTRINSICALLY SAFE FOR HAZARDOUS MINING ENVIRONMENTS

- Intrinsically safe for Mining to:
Ex I/II M1/GD
- Non-contacting inductive technology to eliminate wear
- Travel set to customer's requirement
- Short body length
- Accurate, stable, durable and reliable
- Sealing to IP67



As a leading designer and manufacturer of linear, rotary, tilt and intrinsically safe position sensors, Positek[®] has the expertise to supply a sensor to suit a wide variety of applications.

Our intrinsically safe M103 LIPS[®] (Linear Inductive Position Sensor) incorporates electronics system EX07 which is ATEX / IECEx approved for use in potentially explosive gas/vapour and dust atmospheres and mining environments.

The M103 is designed for a wide range of industrial applications and is ideal for OEMs seeking good sensor performance in situations where a short-bodied sensor is required for operation in hazardous areas. The unit is compact and space-efficient, being responsive along almost its entire length, and like all Positek[®] sensors provides a linear output proportional to travel. Each unit is supplied with the output calibrated to the travel required by the customer, from 2 to 50mm and with full EMC protection built in.

Overall performance, repeatability and stability are outstanding over a wide temperature range.

The sensor has a rugged stainless steel body and plunger. It is easy to install and set up, the stainless steel mounting flange has two 4.5mm by 30 degree wide slots on a 48mm pitch. The plunger can be supplied free or captive, with female M4 thread, or spring-loaded with a ball end. The M103 also offers a range of mechanical options, environmental sealing is to IP67.

SPECIFICATION

Dimensions	
Body diameter	35 mm
Body Length:	Dependant on calibrated travel
Calibrated Travel	
2 mm to 10 mm	81.3 mm
11 mm to 20 mm	91.3 mm
21 mm to 30 mm	101.3 mm
31 mm to 50 mm	121.3 mm
Plunger	Ø 6mm
For full mechanical details see	drawing M103-11
Power Supply	+5V dc nom. ± 0.5V, 10mA typ 20mA max
Output Signal	0.5-4.5V dc ratiometric, Load: 5kΩ min.
Independent Linearity	≤ ± 0.25% FSO @ 20°C ≤ ± 0.1% FSO @ 20°C available upon request.
*Sensors with calibrated travel of 10 mm and above.	
Temperature Coefficients	< ± 0.01%/°C Gain & < ± 0.01%FS/°C Offset
Frequency Response	> 10 kHz (-3dB)
Resolution	Infinite
Noise	< 0.02% FSO
Intrinsic Safety	Ex I/II M1/GD Ex ia IIC T4 Ga (Ta= -40 to 80°C) Ex ia IIIC T135°C Da (Ta= -40 to 80°C) Ex ia I Ma (Ta=-40 to 80°C)
Approval only applies to the specified ambient temperature range and atmospheric conditions in the range 0.80 to 1.10 Bar, oxygen ≤ 21%	
Sensor Input Parameters	Ui: 11.4V, Ii: 0.20A, Pi: 0.51W.
(connector option/s)	Ci: 1.16µF, Li: 50µH
(cable option/s)	Ci: 1.36µF, Li: 860µH with 1km max. cable
Environmental Temperature Limits	
Operating	-40°C to +80°C
Storage	-40°C to +125°C
Sealing	IP67
EMC Performance	EN 61000-6-2, EN 61000-6-3
Vibration	IEC 68-2-6: 10 g
Shock	IEC 68-2-29: 40 g
MTBF	350,000 hrs 40°C Gf
Drawing List	
M103-11	Sensor Outline
Drawings, in AutoCAD [®] dwg or dxf format, available on request.	

Do you need a position sensor made to order to suit a particular installation requirement or specification? We'll be happy to modify any of our designs to suit your needs - please contact us with your requirements.

LIPS[®] M103 SHORT STROKE LINEAR POSITION SENSOR INTRINSICALLY SAFE FOR HAZARDOUS MINING ENVIRONMENTS

Intrinsically safe equipment is defined as "equipment which is incapable of releasing sufficient electrical or thermal energy under normal or abnormal conditions to cause ignition of a specific hazardous atmosphere mixture in its most easily ignited concentration."

ATEX / IECEx approved to;

- Ex I/II M1/GD
- Ex ia IIC T4 Ga (Ta= -40°C to 80°C)
- Ex ia IIIC T135°C Da (Ta= -40°C to 80°C)
- Ex ia I Ma (Ta=-40°C to 80°C)

Designates the sensor as belonging to; Groups I and II: suitable for all areas (including mining), Category M1/1 GD: can be used in areas with continuous, long or frequent periods of exposure to hazardous gas (Zones 2 to 0) and dust (Zone 20), equipment remains energised.

Gas:

Protection class ia, denotes intrinsically safe for all zones Apparatus group IIC: suitable for IIA, IIB and IIC explosive gases.

Temperature class T4: maximum surface temperature under fault conditions 135°C.

Dust:

T135°C: maximum surface temperature under fault conditions 135°C.

Ambient temperature range extended to -40°C to +80°C.

It is imperative Positek[®] intrinsically safe sensors be used in conjunction with a galvanic barrier to meet the requirements of the product certification. The Positek X005 Galvanic Isolation Amplifier is purpose made for Positek IS sensors making it the perfect choice. Refer to the X005 datasheet for product specification and output configuration options.

Safety Parameters:-

- Ui: 11.4V, Ii: 0.20A, Pi: 0.51W
- Ci = 1.36µF* Li = 860µH* (cable option/s)
- Ci = 1.16µF Li = 50µH (connector option/s)

*Figures for 1km cable where: Ci = 200pF/m & Li = 810nH/m

Sensors can be installed with a maximum of 1000m of cable.

Cable characteristics must not exceed:-

- Capacitance: ≤ 200 pF/m for max. total of: 200 nF.
- Inductance: ≤ 810 nH/m for max. total of: 810 µH

For cable lengths exceeding 10 metres a five wire connection is recommended to eliminate errors introduced by cable resistance and associated temperature coefficients.

ATEX / IECEx approved sensors suitable for gas (X series) and dust (E series) applications, are also available from Positek.

TABLE OF OPTIONS

CALIBRATED TRAVEL: Factory set to any length from 0-2mm to 0-50mm (e.g. 36mm).

ELECTRICAL INTERFACE OPTIONS

The Positek[®] X005 Galvanic Isolation Amplifier is available with the following output options;

- Standard: 0.5 - 9.5V or 4 - 20mA.
- Reverse: 9.5 - 0.5V or 20 - 4mA.

CONNECTOR/CABLE OPTIONS

- Connector - Binder 713 series IP67
- Cable[†] with Pg 9 gland or short gland IP67

[†]Three core (black jacket) or five core (blue jacket) cable options available. Cable length >50 cm – please specify length in cm up to 15000 cm max. maximum.

We recommend all customers refer to the 3 or 5-Wire Mode Connection page.

PUSH ROD OPTIONS – standard retained with M4x0.7 female thread Sprung loaded (spring supplied loose), Dome end (sprung loaded) or Free.

Output Characteristic - Standard

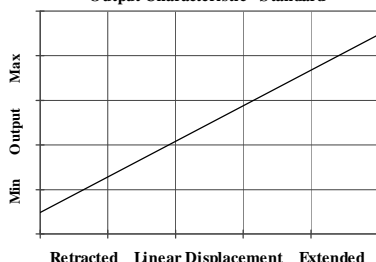

For further information please contact:

www.positek.com sales@positek.com

Tel: +44(0)1242 820027 fax: +44(0)1242 820615

Positek Ltd, Andoversford Industrial Estate, Cheltenham GL54 4LB U.K.



M103-17o

Three or Five-Wire Mode Connection FOR INTRINSICALLY SAFE SENSORS IN HAZARDOUS ATMOSPHERES

The aim of this document is to help readers who do not understand what is meant by three or five wire modes of connection between the galvanic isolation amplifier and sensor, and the factors behind them. It is by no means an in-depth technical analysis of the subject.

Whether opting for a pre-wired Positek® Intrinsicly Safe sensor or one with a connector, choosing the right mode of connection and cable to suit the application requires careful consideration.

Interconnecting cables are not perfect conductors and offer resistance to current flow, the magnitude of resistance[†] depends on conductors resistivity, which changes with temperature, cross sectional area[‡] and length. If the voltage were to be measured at both ends of a length of wire it would be found they are different, this is known as volts drop. Volts drop changes with current flow and can be calculated using Ohm's law, it should be noted that volts drop occurs in both positive and negative conductors. The effects of volts drop can be reduced by increasing the conductors cross sectional area, this does not however eliminate the effects due to temperature variation. There are instances where large cross-section cables are not practical; for example most standard industrial connectors of the type used for sensors have a maximum conductor capacity of 0.75mm², copper prices and ease of installation are other considerations.

This is important because the effects of volts drop can significantly alter the perceived accuracy of the sensor which is ratiometric i.e. the output signal is directly affected by the voltage across the sensor. Changes in temperature will also be seen as gain variation in the sensor output.

Three wire mode connections are common and are suitable in most cases with short or moderate cable runs. Applications that do not require a high degree of accuracy but have cable runs, say in excess of 10m, volts drop can be reduced by introducing a terminal box close to the sensor and using a larger cross-section cable for a majority of the cable run. Sensors supplied with three core cable are calibrated with the cable fitted which largely eliminates errors due to conductor resistance at room temperature however, as mentioned above, small gain errors due to temperature fluctuations should be expected.

Five wire mode connections have significant benefits as losses in the positive and negative conductors are compensated for by the galvanic isolation amplifier which can 'sense' the voltage across the sensor and dynamically adjust the output voltage so that the voltage across the sensor is correct. The effects of cable resistance and associated temperature coefficients are eliminated allowing for smaller conductors than a three wire connection for the same cable run. The amplifier can compensate for up to 15Ω per conductor with a current flow of 15mA, which is more than adequate for 150m of 0.25 mm² cable, longer lengths will require larger conductors.

For this reason Positek® recommends five wire connections for cable lengths exceeding 10 metres in 0.25 mm² cable to preserve the full accuracy of the sensor.

See illustrations below for examples of connecting a sensor to the galvanic isolation amplifier.

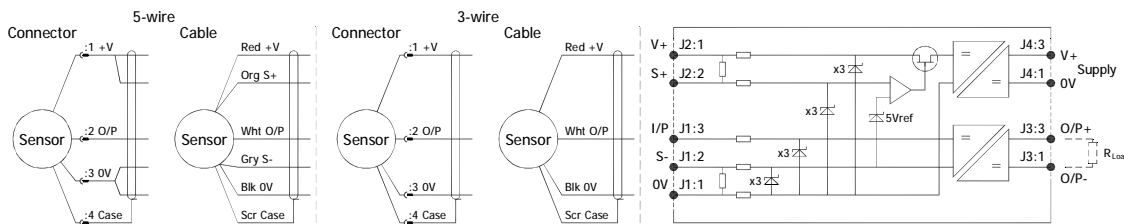

Cable Length (metres)	Up to 150	150 - 300	300 - 450	450 - 600	600 - 900	900 - 1000
Cross Section (mm ²)	0.25	0.5	0.75	1.0	1.5	2.0

The table above shows recommended conductor sizes with respect to cable length for both three and five wire connections, based on copper conductors. Three wire connections will introduce a gain reduction of 5% and a ±1% temperature dependence of gain over the range -40°C to +80°C for the cable temperature. (i.e. about -150 ppm/°C for the maximum lengths shown and less pro rata for shorter lengths.)

It should be noted that the maximum cable length, as specified in the sensor certification, takes precedence and must not be exceeded.

Positek® sensors are supplied with three core 0.25 mm² cable as standard, however five core 0.25 mm² cable can be supplied on request. The galvanic isolation amplifier is available as;

G005-*** for 'G' and 'H' prefix sensors
 X005-*** for 'E', 'M' and 'X' prefix sensors

[†] $R = \rho L/A$ ρ is the resistivity of the conductor (Ωm) L is the length of conductor (m) A is the conductor cross-sectional area (m²).

[‡] It is presumed that direct current flow is uniform across the cross-section of the wire, the galvanic isolation amplifier and sensor are a dc system.

Intrinsically Safe - Mining Environments

LIPS® SERIES M103 Short Stroke Position Sensor

a	b	c	d	e	f	g	h	j	k	
M103	Displacement	A	Y	Connections	N	Option	Option	Option	Option	Z-code

a Displacement (mm)		Value
Displacement in mm	e.g. 0 - 22 mm	22
b Output		
Supply V dc V _s (tolerance)	Output	Code
+5V (4.5 - 5.5V)	0.5 - 4.5V (ratiometric with supply)	A
c Calibration Adjustments		Code
Sealed		Y
d Connections Cable* or Connector		Code
Connector	IP67 M12 IEC 60947-5-2	J
Cable Gland	IP67 M12 - 3-core cable	Lxx
Cable Gland	IP67 M12 - 5-core cable	LQxx
Cable Gland	IP67 Short - 3-core cable	Mxx
Cable Gland	IP67 Short - 5-core cable	MQxx
*Supplied with 50 cm as standard, specify required cable length specified in cm. e.g. L2000 specifies cable gland with 20 metres of cable. Nb: restricted cable pull strength.		
e Housing		Code
Flange Mount		N
f Body Fittings		Code
None - default		blank
Body Clamps - 1 pair		P
g Sprung Plunger		Code
None - default		blank
Spring Extend	Captive plunger only.	R
h Plunger Fittings		Code
None - default		Female Thread M4x0.7x7 deep
Dome end	Required for option 'R'	T
j Plunger Options		Code
Captive - default		Plunger is retained
Non-captive		Plunger can depart body
		V

k Z-code	Code
Calibration to suit X005 - Default	Z000
≤± 0.1% @20°C Independent Linearity displacement between 10mm & 50mm only!	Z650
Connector with cable option 'J' or 'JQ' with length required in cm i.e. J100 specifies connector with 100cm of cable.	Z999

Note!

All Intrinsically Safe (IS) sensors must have a Z-code suffix.
IS sensors must be used in conjunction with a Galvanic Isolation Amplifier - See X005 for Output options.

Installation Information

LIPS[®] M103 SHORT STROKE LINEAR POSITION SENSOR INTRINSICALLY SAFE FOR HAZARDOUS MINING ENVIRONMENTS

For certificate number and safety parameters information for product marked EX04, see next page.

ATEX /IECEx Qualified to Intrinsic Safety Standard Certificate numbers SIRA 13ATEX2371X IECEx SIR 13.0154X		Ex I/II M1/1GD Ex ia IIC T4 Ga (Ta = -40°C to +80°C) Ex ia IIIC T135°C Da (Ta = -40°C to +80°C) Ex ia I Ma (Ta = -40 to +80°C)	
Electronics Version	Output Description:	Supply Voltage: V _s (tolerance)	Load resistance:
EX07	0.5 - 4.5V (ratiometric with supply) [Output code 'A']	+5V (4.5 - 5.5V)	5kΩ min

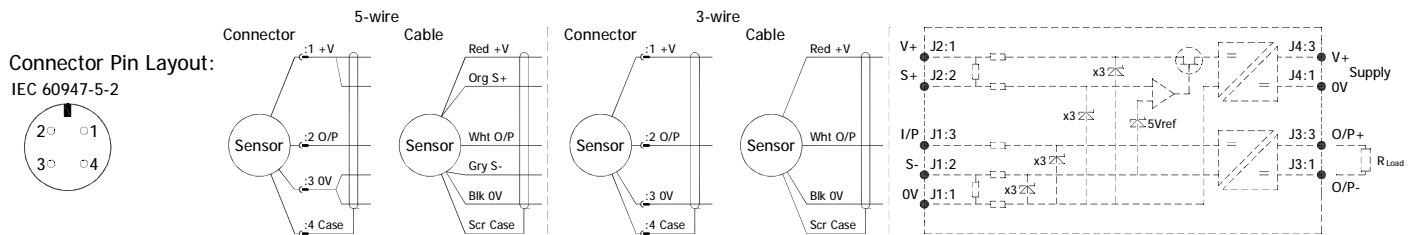

Putting Into Service: The sensor must be used with a galvanic isolation barrier designed to supply the sensor with a nominal 5V and to transmit the sensor output to a safe area. The barrier parameters must not exceed:-

$$\begin{array}{lll}
 U_i = 11.4V & I_i = 0.20A & P_i = 0.51W \\
 C_i = 1.36\mu F^* & L_i = 860\mu H^* & \text{('Lxx', 'LQxx', 'Mxx' or 'MQxx' options)} \\
 C_i = 1.16\mu F & L_i = 50\mu H & \text{('J' option)} \quad * \text{Figures for 1km cable}
 \end{array}$$

The sensor is certified to be used with up to 1000m of cable, cable characteristics must not exceed:-

$$\begin{array}{ll}
 \text{Capacitance:} & \leq 200 \text{ pF/m for max. total of: } 200 \text{ nF} \\
 \text{Inductance:} & \leq 810 \text{ nH/m for max. total of: } 810 \mu H
 \end{array}$$

Approval only applies to specified ambient temperature range and atmospheric conditions in the range: 0.80 to 1.10 Bar, oxygen ≤ 21%.

The performance of the sensor may be affected by voltage drops associated with long cable lengths; For cable lengths exceeding 10 metres a five wire connection is recommended to eliminate errors introduced by cable resistance and associated temperature coefficients.

N.b. sensors supplied with cable, the free end must be appropriately terminated.

Warning - The M12 IEC 60947 connector may be rotated for purposes of convenient orientation of the connector and cable, however rotating the connector more than one complete revolution is not recommended.

Repeated rotation of the connector will damage the internal wiring!

Special Condition for Safe Use:

The apparatus does not meet the 500 V r.m.s dielectric strength test between circuit and frame, in accordance with clause 6.3.13 of IEC 60079-11:2011. This must be taken into consideration on installation.

When using a Sensor that has an integral cable in a dust application, the free end of the cable shall be appropriately terminated for the zone of use.

Under certain extreme circumstances, the non-metallic and isolated metal parts incorporated in the enclosure of this equipment may generate an ignition-capable level of electrostatic charge. Therefore the equipment shall not be installed in a location where the external conditions are conducive to the build-up of electrostatic charge on such surfaces. This is particularly important if the equipment is installed in a zone 0 location. In addition, the equipment shall only be cleaned with a damp cloth.

Use: The sensor is designed to measure linear displacement and provide an analogue output signal.

Assembly and Dismantling: The unit is not to be serviced or dismantled and re-assembled by the user.

Maintenance: No maintenance is required. Any cleaning must be done with a damp cloth.

Mechanical Mounting: Via the two slots in the flange, the slots are 4.5 mm by 30 degrees wide on a 48 mm pitch.

Output Characteristic: Plunger extended 10 mm* from mounting face at start of normal travel.

*Note: where dome end option is fitted add 5 mm.

The output increases as the plunger extends from the sensor body, the calibrated stroke is between 2 mm and 50 mm.

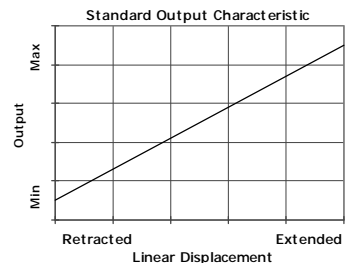

Incorrect Connection Protection levels: Not protected – the sensor is not protected against either reverse polarity or over-voltage. The risk of damage should be minimal where the supply current is limited to less than 50mA.



Installation Information

LIPS[®] M103 SHORT STROKE LINEAR POSITION SENSOR INTRINSICALLY SAFE FOR HAZARDOUS MINING ENVIRONMENTS

For certificate number and safety parameters information for product marked EX07, see previous page.

ATEX Qualified to Intrinsic Safety Standard Certificate numbers SIRA 00ATEX2076X		Ex I/II M1/1GD EEx ia I/IIC T4 (Ta = -40°C to +80°C) Ex ia D 20 T135°C (Ta = -40°C to +80°C)	
Electronics Version	Output Description:	Supply Voltage: V _s (tolerance)	Load resistance:
EX04	0.5 - 4.5V (ratiometric with supply) [Output code 'A']	+5V (4.5 - 5.5V)	5kΩ min

The barrier parameters must not exceed:-

U_i = 11.4V **I_i = 0.20A** **P_i = 0.51W**
C_i = 1.36μF* **L_i = 710μH*** ('Lxx' option) *Figures for 1km cable
C_i = 1.16μF **L_i = 50μH** ('J' option)

The sensor is certified to be used with up to **1000m** of cable, cable characteristics must not exceed:-

Capacitance: ≤ 200 pF/m for max. total of: 200 nF
 Inductance: ≤ 660 nH/m for max. total of: 660 μH

With the exception of the certificate number and safety parameters above, all other notes regarding Putting Into Service, Use, Assembly and Dismantling etc. on previous page apply to sensors marked EX04 or EX07.

