



Accessories

10030342 - M12, 5pin B-Coded, Female



Characteristics of Head 1

Standards/Regulations	M12 Connector
Coding	B - Coded (inverse)
Gender	Female
Number of Positions	05
Contact Surface Material	Au
Housing Material	Zinc Die-cast, Nickel Plated
Knurls Material	Zinc die-cast, nickel-plated
Contact Connection Method	Screw Connection
Degree of Protection	IP67
Fixing Torque	0.4 Nm (M12 Connector)
Cable Diameter Range	6 - 8 mm
Conductor AWG Range	24 - 18
Cross Section Range	0.25 - 0.75 mm ²

General Data

Ordering Code	10030342 - CTR-M12S-F05B-NPSC
Weight	50 g
Operating Temperature	-40 °C / -40° F to 85 °C / 185° F

Data Sheet

Printed at 8-12-2023 20:12



Pin Assignment

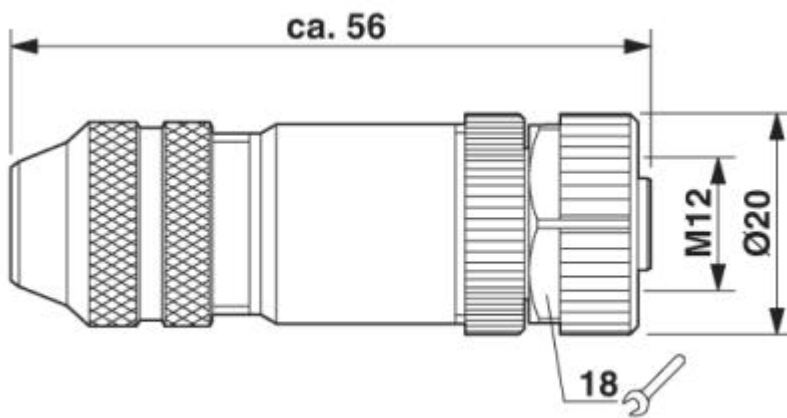
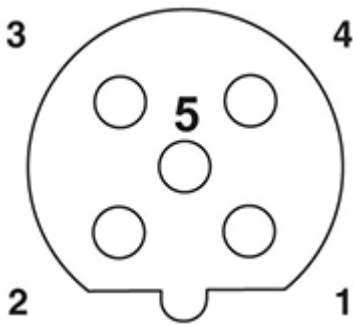

Contact



Contact Us

All dimension in [inch] mm. This drawing and the information contained is for general presentation purposes only. Please refer to the "Download" section for detailed technical drawings. © FRABA B.V., All rights reserved. We do not assume responsibility for technical inaccuracies or omissions. Specifications are subject to change without notice.