



ABSOLUTE IXARC MAGNETIC ROTARY ENCODER
WITH ANALOG INTERFACE



ANALOG

User Manual

IXARC UCD Analog Current + Voltage



ABSOLUTE IXARC MAGNETIC ROTARY ENCODER WITH ANALOG INTERFACE

Table of Contents

1. Introduction.....	3
1.1 IXARC Magnetic Encoders.....	3
1.2 General Information.....	3
2. Electrical Data.....	5
2.1 General Data.....	5
3. Interface.....	6
3.1 Output Characteristics of Scalable Encoders Incorporating Pushbutton and Non-Pushbutton Versions (UCD-AxP0x-... or UCD-Ax00x-...)	6
3.2 Output Characteristics of Encoders with Zero Set and Direction Set but no Scaling Functionality (UCD-Ax10x-..).....	10
3.3 Analog Accuracy	11
4. Pin Configuration and Wiring	11
4.1 Adapter cables for encoders with connectors and their wiring	12
5. Scaling Functionality.....	13
5.1 Scaling Functionality For Non-Pushbutton Versions (UCD-Ax0xx-..)	13
5.2 Scaling Functionality For Pushbutton Versions (UCD-AxPxx-..).....	14
5.3 Versions with Zero Set and Direction Set but no Scaling (UCD-Ax1xx-..).....	15

ABSOLUTE IXARC MAGNETIC ROTARY ENCODER WITH ANALOG INTERFACE

1. Introduction

1.1 IXARC Magnetic Encoders

This manual explains how to install and configure the IXARC absolute rotary encoder with Analog interface. Magnetic rotary encoders determine positions using the Hall effect sensor technology developed for the automotive mass market. A permanent magnet fixed to the shaft generates a magnetic field that is sampled by the Hall sensor, which translates the measured value into a unique absolute position value. To register revolutions even when no voltage is applied, energy from the turning of the shaft must suffice for proper operation. An innovative, patented technology makes this feasible even at low rotational speeds and through long standstill periods – a Wiegand wire ensures that the magnetic field can only follow the turning of the shaft in discrete steps. A coil wound on the Wiegand wire receives only brief, strong voltage spikes, which prompt the reliable recognition of each revolution.

1.2 General Information

This description is not intended to replace the documentation for the product concerned. Hazardous voltage and mechanisms, death, or serious injury due to electrical shock, burns and entanglement in moving parts, or property damage will result if safety instructions in the documentation are not followed. Do not service or touch until you have de-energized high voltage, grounded all terminals and turned off the control voltage. If the pertinent documentation is not in your hands, please ask for it using the order key in the product catalog or contact your FRABA POSITAL contact person. Only proper trained staff aware of local safety regulations are allowed to commission and operate, or to work on and around this product after procedures contained in the documentation. Before touching electronic assemblies make sure static charges are eliminated by touching an earthed component.

Instructions to mechanically install and electrically connect the angular encoder



Do not remove or mount the connector while the encoder is powered on!



Do not stand on the encoder!



Do not adapt the driving shaft additionally!



Avoid mechanical load!



Do not adapt the housing additionally!



ABSOLUTE IXARC MAGNETIC ROTARY ENCODER WITH ANALOG INTERFACE

High-resolution absolute rotary encoder with analog output based on contactless magnetic Hall Effect technology. The Multi Turn rotary encoder can measure up to 65536 revolutions (16Bit). The Voltage or Current output of this rotary encoder is programmable, thus it can be scaled to fit perfect in any kind of application, particularly as a

replacement for potentiometers. The PushButton and visible LED feedback makes the programming very easy. This rotary encoder can be used as a replacement for less reliable Multi Turn potentiometers. The sensor can be also used as an economical Multi Turn feedback sensor for low cost control systems with analog inputs.

Main Features

- Compact Industrial Design
- Interface: Analog – Current, Voltage
- Housing: Ø 36,5 mm
- Shaft: Ø 6 mm
- Blind Hollow / Hub Shaft: Ø 6 mm
- 12 Bit Total Resolution
- Factory Default Turns: 16 (0 To 5760°)
- Inputs for User Defined Measuring Range
- Over Range and Under Range Deadband
- EMC: EN 61000-6-2, EN 61000-6-4

Mechanical Structure

- Aluminum Flange
- Coated Steel Housing
- Stainless Steel Shaft
- Precision Ball Bearings

Suitable for Applications Requiring

- Packaging machines
- Material Handling
- Buses and Trucks
- Solar Tracking
- Wind Turbines
- Construction Machines
- Defense Equipment

Electrical Features

- Reverse Voltage Protection
- Over-Voltage Protection
- Programmable Measurement Range
- Short Circuit Protection of Output

ABSOLUTE IXARC MAGNETIC ROTARY ENCODER WITH ANALOG INTERFACE

2. Electrical Data

Current Options	4–20 mA	0–20 mA
Max Load Resistance	500 Ω	
Supply Voltage ¹	8–32 V DC (absolute maximum ratings)	
Linearity	0.15 %	
Analog Accuracy	@ 20mA = $\pm 20 \mu\text{A}$ (for ideal power supply) ²	
Settling Time	32 ms	
Current Consumption	Typical 20 mA @24 V DC (no load)	

Voltage Options	0–5 V	0.5–4.5V	0–10 V	0.5–9.5V
Min Load Resistance	5 k Ω			
Supply Voltage ¹	8–32 V DC (absolute maximum ratings)			
Linearity	0.15%			
Analog Accuracy	@ 10V = $\pm 10\text{mV}$ (for ideal power supply) ²			
Settling Time	32 ms			
Current Consumption	Typical 15 mA @24 V DC (no load)			

1) Supply voltage according to EN 50 178 (safety extra-low voltage)

2) The analog accuracy would be less (the numeric value stated greater) if a non-steady or switching power supply is used

2.1 General Data

Turn On Time	< 1 s
Minimum Measurement Range	0 to 11.25 °

ABSOLUTE IXARC MAGNETIC ROTARY ENCODER WITH ANALOG INTERFACE

3. Interface

3.1 Output Characteristics of Scalable Encoders Incorporating Pushbutton and Non-Pushbutton Versions (UCD-AxP0x-... or UCD-Ax00x-...)

Code sense: Counter clockwise (CCW) shaft movement (front view on shaft) leads to increasing analog output

Analog output of standard singleturn (ST) and multiturn (MT) encoders with factory settings:

- Type keys of ST encoders: UCD-AxP0x-0013-... or UCD-Ax00x-0013-...
- Type keys of MT encoders: UCD-AxP0x-0413-... or UCD-Ax00x-0413-...

The graph below shows the output of the standard ST and MT encoders obeying the type keys denoted above with factory settings. For ST encoders the default measuring range (denoted as MR_d on the x-axis) equals 360° , whereas for MT encoders the default measuring range MR_d equals 16 turns, i.e. 5760° .

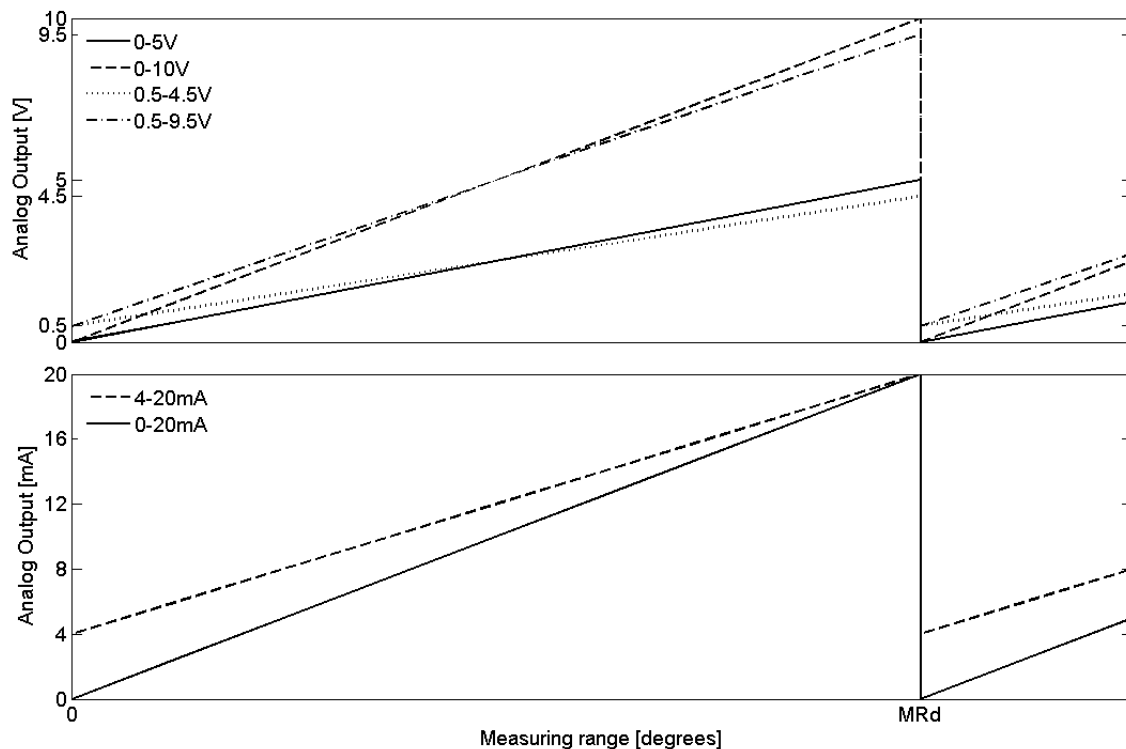

ABSOLUTE IXARC MAGNETIC ROTARY ENCODER WITH ANALOG INTERFACE

Analog output of ST encoders with fractional-turn measuring ranges as factory settings:

Type keys: UCD-AxP0x-00yy-... or UCD-Ax00x-00yy-...

You may order ST encoders having less than one turn measuring range as factory setting using the type key structure above, where yy= AP, AR or AS for default measuring ranges of 90°, 180°, and 270°, respectively.

The graph below shows the output of these encoders taking their respective default measuring ranges (denoted as MR_d on the x-axis) of 90°, 180° and 270° into account. The encoders operate as default in rollover mode. Rollover (denoted as RO on the x-axis) occurs at the midpoint between MR_d and 360°. Hence, RO equals 225°, 270° and 315° for yy= AP, AR, AS respectively.

For measuring ranges between MR_d and 360° the encoder operates in the deadband regime, i.e. the output of the encoder equals the constant high and low deadband values when the measuring range is between (MR_d & RO) and (RO & 360°), respectively. The low and high deadband values for different encoder types are listed in the table below.

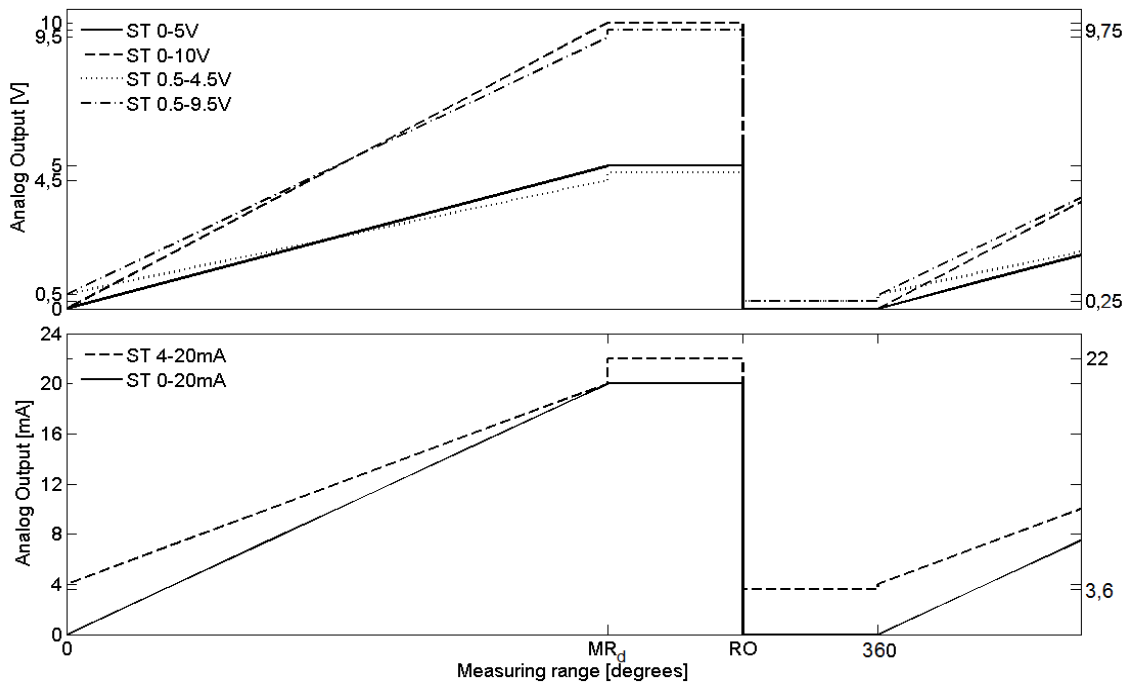

Deadband Values [mA/V]

Encoder Type	Low	High
0–5 V	0 V	5 V
0.5–4.5 V	0.25 V	4.75 V
0–10 V	0 V	10 V
0.5–9.5 V	0.25 V	9.75 V
4–20 mA	3.6 mA	22 mA
0–20 mA	0 mA	20 mA

ABSOLUTE IXARC MAGNETIC ROTARY ENCODER WITH ANALOG INTERFACE

Analog output of user scaled ST encoders:

Type keys: UCD-AxP0x-00yy-... or UCD-Ax00x-00yy-...

The graph below shows the output of the encoders for an exemplary scaled measuring range (denoted as MR_s on the x-axis) of $60^\circ, 120^\circ, 180^\circ, 240^\circ$ for yy= AP; AR; AS; 13, respectively.

The encoder operates as default in rollover mode. Rollover (denoted as RO on the x-axis) occurs at the midpoint between MR_s and 360° . Hence, for the exemplary MR_s denoted above RO equals $210^\circ, 240^\circ, 270^\circ$ and 300° for yy= AP; AR; AS; 13, respectively.

For measuring ranges between MR_s and 360° the encoder operates in the deadband regime, i.e. the output of the encoder equals the constant high and low deadband values when the measuring range is between (MR_s & RO) and (RO & 360°), respectively. The low and high deadband values for different encoder types are listed in the table below.

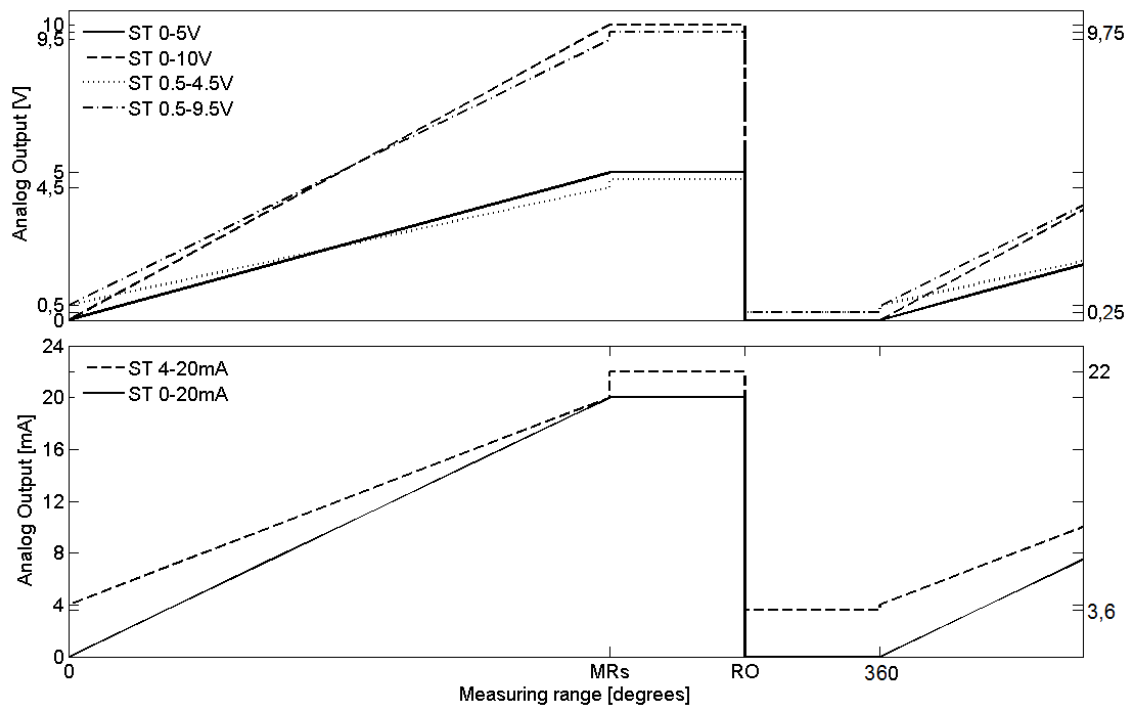

Encoder Type	Deadband Values [mA/V]	
	Low	High
0–5 V	0 V	5 V
0.5–4.5 V	0.25 V	4.75 V
0–10 V	0 V	10 V
0.5–9.5 V	0.25 V	9.75 V
4–20 mA	3.6 mA	22 mA
0–20 mA	0 mA	20 mA

ABSOLUTE IXARC MAGNETIC ROTARY ENCODER WITH ANALOG INTERFACE

Analog output of user scaled MT encoders:

Type keys: UCD-AxP0x-0413-... or UCD-Ax00x-0413-...

Principally, the measuring range of MT encoders can be scaled up to 2^{16} turns. The graph below shows the output of the encoders for an exemplary scaled measuring range (denoted as MR_s on the x-axis) of 3600° or in terms of user scaled turns $n_s = 10$.

The encoder operates as default in rollover moder. Rollover (denoted as RO on the x-axis) occurs at the midpoint between the scaled measuring range MR_s and $MR_d = 2^n \times 360^\circ$, where n is the smallest integer satisfying $2^n \geq n_s$. In the exemplary case shown in the graph below MR_d equals $2^4 \times 360^\circ = 5760^\circ$.

For measuring ranges between MR_s and MR_d the encoder operates in the deadband regime, i.e. the output of the encoder equals the constant high and low deadband values when the measuring range is between (MR_s & RO) and (RO & MR_d), respectively. The low and high deadband values for different encoder types are listed in the table below.

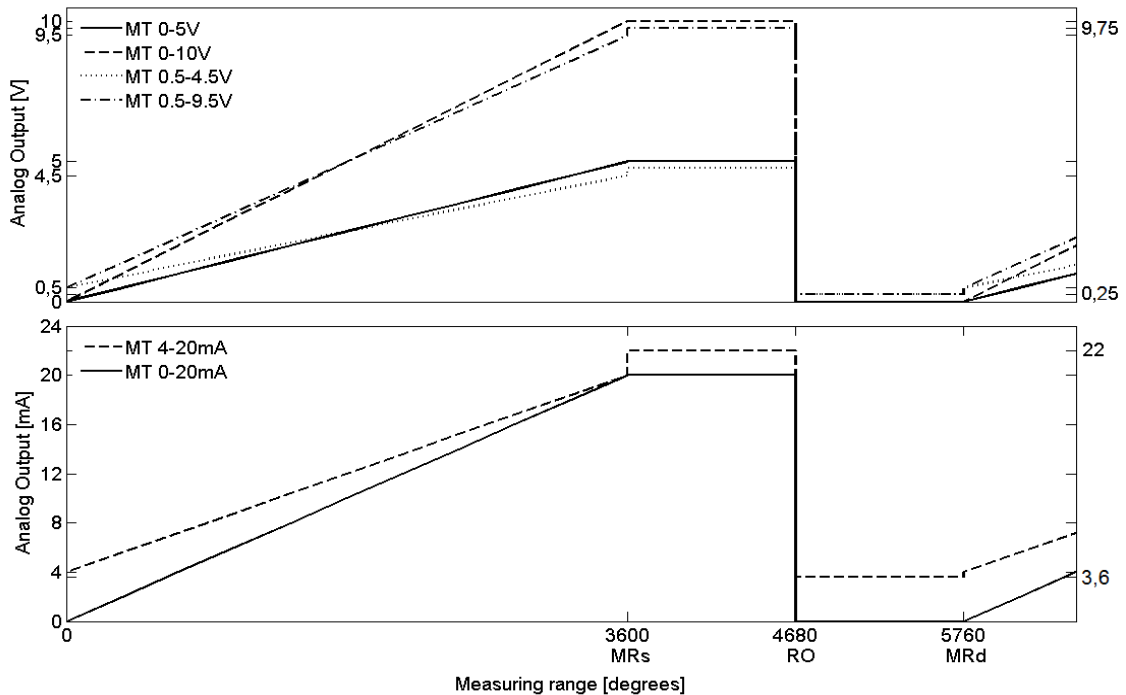

Encoder Type	Deadband Values [mA/V]	
	Low	High
0–5 V	0 V	5 V
0.5–4.5 V	0.25 V	4.75 V
0–10 V	0 V	10 V
0.5–9.5 V	0.25 V	9.75 V
4–20 mA	3.6 mA	22 mA
0–20 mA	0 mA	20 mA

ABSOLUTE IXARC MAGNETIC ROTARY ENCODER WITH ANALOG INTERFACE

3.2 Output Characteristics of Encoders with Zero Set and Direction Set but no Scaling Functionality (UCD-Ax10x-..)

Code sense : Clockwise shaft movement (front view on shaft) leads to increasing analog output

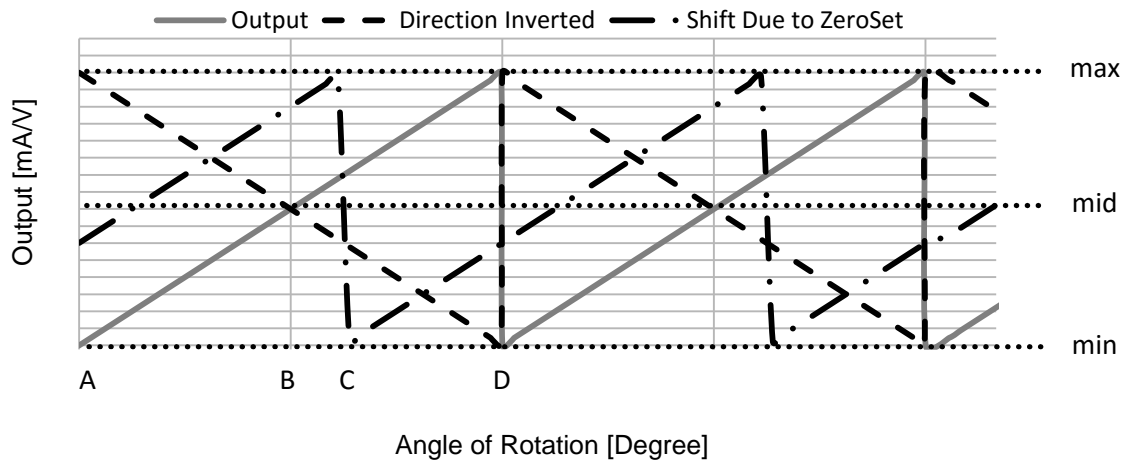

Encoder Type	Absolute Position [Degree]			
	A	B	C	D
UCD-AX10X-0013-...	0	180°	Zero Set Position	360° or 0°
UCD-AX10X-0413-...	0	2880°	Zero Set Position	5760° or 0°

Encoder Type		Analog Output Value [mAV]		
		max	mid	min
0–5 V	UCD-AV101-...	0 V	2.5 V	5 V
0.5–4.5 V	UCD-AV103-...	0.5 V	2.5 V	4.5 V
0–10 V	UCD-AV102-...	0 V	5 V	10 V
0.5–9.5 V	UCD-AV104-...	0.5 V	5 V	9.5 V
4–20 mA	UCD-AC105-...	4 mA	12 mA	20 mA
0–20 mA	UCD-AC106-...	0 mA	10 mA	20 mA

ABSOLUTE IXARC MAGNETIC ROTARY ENCODER WITH ANALOG INTERFACE

3.3 Analog accuracy

The total analog accuracy of the encoder depends on the following factors:

- Linearity: Deviation from ideal linear transfer function [%]
- Analog accuracy: Offset at endpoints, basically linear function with different slope

The total analog accuracy of the encoder depends on the measuring range since analog errors are only dependent on the output range. Using the mini-tool below the total analog accuracy error can be calculated in units of degrees and also percentage of the measuring range after selecting the output and measuring range of the encoder and specifying the offset. Major influences on the total analog accuracy are caused by the offsets which are typically compensated for at application setup. Therefore the default value for the Offset/Accuracy field is selected to be 0. Nevertheless, the user can enter non-zero offset values to analyze its effects on the total analog accuracy.

Inputs			Total analog accuracy	
Encoder type	Measuring range [number of turns]	Offset/Accuracy [mV/μA]	[% of measuring range]	[Degrees]

4. Pin Configuration and Wiring

- Connect using a female M12 5pin round connector with a tightening torque in the range of 0.4 – 0.6 Nm
- IP69K protection guaranteed only with appropriate mating connector and secure connection
- Use a shielded cable for maximum protection from electromagnetic interference

Pin M12	Wire End	Function
1	Green	Current/Voltage Output
2	Red	+ V _S Supply Voltage
3	Yellow	GND (Supply)
4	White	Set 2 / Zero Set
5	Brown	Set 1 / Direction
		Shielding

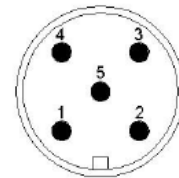

5 pin M12 Male Front View on Encoder

- **WARNING:** For pushbutton versions, i.e. those with type keys UCD-AxP..., do not use the pins/wires for Set 1 and Set 2 along with the pushbuttons at the same time while scaling and with different voltages.

ABSOLUTE IXARC MAGNETIC ROTARY ENCODER WITH ANALOG INTERFACE

3.3 Adapter cables for encoders with connectors and their wiring

If you have purchased an encoder with a 5pin M12 connector you could make use of the adapter cables listed below for your application. The contact assignment and the color code of wires of these adapter cables are shown below.

Pin assignment:

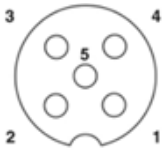

Contact assignment:

- 10017217 - 2m PUR Cable, 5pin, A-Coded, f
- 10017218 - 5m PUR Cable, 5pin, A-Coded, f
- 10017031 - 10m PUR Cable, 5pin, A-Coded, f

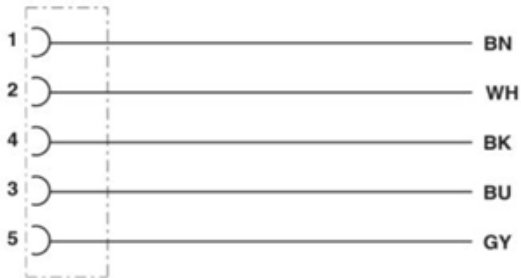

- 10032662 - 10m PUR Cable, 5pin, A-Coded, f



ABSOLUTE IXARC MAGNETIC ROTARY ENCODER WITH ANALOG INTERFACE

5. Scaling Functionality

5.1 Scaling Functionality For Non-Pushbutton Versions (UCD-Ax0xx-...)

Using the Set 1 and Set 2 input signals the measuring range (min range of 11.25°) with the analog output range can be scaled

- Turn the encoder shaft to the min position (One end of the measuring range)
- Connect Set 1 signal to high level for 1 second
- On release the analog output value jumps to the minimum output value (e.g.: 4 mA)
- Turn the encoder shaft to the max position (Other end of the measuring range)
- Connect Set 2 signal to high level for 1 second
- On release the analog output value jumps to the maximum output value (e.g.: 20 mA)
- Analog output is scaled to the new measuring range

Set 2 (White)	Set 1 (Brown)	Function / Output Value
0 (Input = N.C. or GND)	0 (Input = N.C. or GND)	Normal Operation
0 (Input = N.C. or GND)	1 (Input $\geq 5\text{ V}$ / Input $\leq V_S$)	Preset Zero Point / Minimum
1 (Input $\geq 5\text{ V}$ / Input $\leq V_S$)	0 (Input = N.C. or GND)	Preset Max Point / Maximum
1 (Input $\geq 5\text{ V}$ / Input $\leq V_S$)	1 (Input $\geq 5\text{ V}$ / Input $\leq V_S$)	Reset Midpoint of Default Scale ¹⁾

1) See table on page 10 for exact values.

Additionally, using the sequence shown in the table below the counting direction can also be changed after teach-in.

Teach-in mode					Results after teach-in
SET1	Release SET1	Set Range with Direction: Turning CW (as seen on shaft)	SET2	Release SET2	Turn CW (as seen on shaft) → Encoder is counting UP
SET1	Release SET1	Set Range with Direction: Turning CCW (as seen on shaft)	SET2	Release SET2	Turn CW (as seen on shaft) → Encoder is counting DOWN
SET2	Release SET2	Set Range with Direction: Turning CW (as seen on shaft)	SET1	Release SET1	Turn CW (as seen on shaft) → Encoder is counting DOWN
SET2	Release SET2	Set Range with Direction: Turning CCW (as seen on shaft)	SET1	Release SET1	Turn CW (as seen on shaft) → Encoder is counting UP

ABSOLUTE IXARC MAGNETIC ROTARY ENCODER WITH ANALOG INTERFACE

5.2 Scaling Functionality For Pushbutton Versions (UCD-AxPxx-...)

Using the Lim1 and Lim2 pushbuttons on the housing the measuring range (min range of 11.25°) with the analog output range can be scaled

- Press Lim1 and Lim2 together for 15 sec to enter programming mode
 - Turn the encoder shaft to the min position (One end of the measuring range)
 - Press Lim1 for 1 sec
 - Turn the encoder shaft to the max position (Other end of the measuring range)
 - Press Lim2 for 1 sec
 - Analog output is scaled to the new measuring range
- WARNING: Do not use the pins/wires for Set1 and Set 2 along with the pushbuttons at the same time for scaling and with different voltages.

Timing Value: Operation Mode

Action	Time (Sec)	Device State
Both Buttons	15.0	Enter programming mode
Both Buttons	30.0	Reset to Mid of default
Single Button	–	Normal operation

Timing Value: Programming Mode

Action	Time (Sec)	Device State
Both buttons	–	Abort programming mode
Lim 1 pressed	1.0	Set position 1
Lim 2 pressed	1.0	Set position 2



LED States

Yellow LED	Green LED	Description
On	Off	Operation with default scale ("factory mode")
Off	On	Operation with user scale
On	On	Entering programming mode (temporary state)
Flashing	Flashing	Programming mode
On	Flashing	Position 2 set, waiting for position 1
Flashing	On	Position 1 set, waiting for position 2

5.3 Versions with Zero Set and Direction Set but no Scaling (UCD-Ax1xx-...)

Direction Change

- Please set the direction before Zero Setting the encoder
- When the Direction pin is connected to GND or not connected, the encoder has a increasing output signal when the shaft is turned clockwise
- When the Direction pin is connected to $\geq 5\text{ V}$ up to max Supply Voltage the encoder changes the signal sense, i.e. CCW shaft movement leads to increasing analog output value
- The Direction pin needs to be always connected to $\geq 5\text{ V}$ for this functionality to remain

Preset Functionality

- Connect the Zero Set pin to greater than or equal to 5 V & less than 32 V for at least $T=100\text{ msec}$
- On releasing the pin the encoder output is set to the min position
- Make sure the shaft is not moving during zero setting

The Preset function allows setting the analog output value to min value at the present mechanical position. Input resistance is at high impedance.

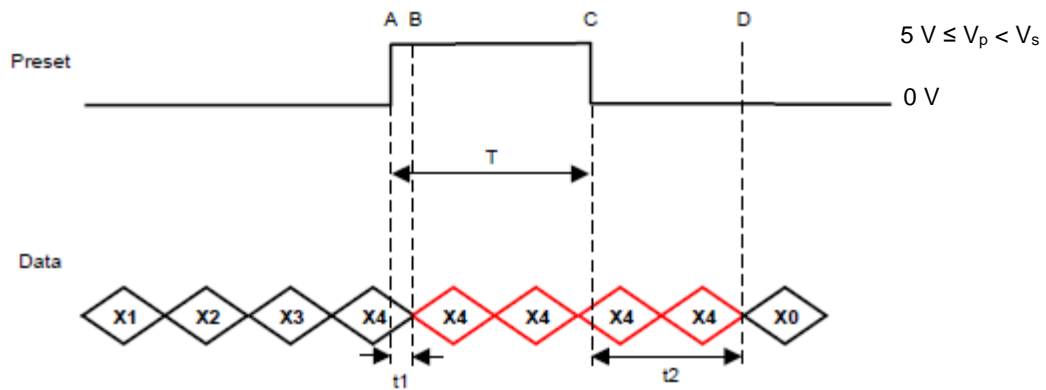

$$T = 103\text{msec} \pm 2\text{msec}$$

$$t1 = 3\text{msec} \pm 2\text{msec}$$

$$T+t2 = 225\text{msec} (\pm 13\text{msec})$$

Disclaimer

© FRABA B.V. all rights reserved. We do not assume responsibility for technical inaccuracies or omissions. Specifications are subject to change without notice.